



PROYECTO ILUMINACIÓN

Septiembre 2024



MACROLED®

inteck

POWERSWITCH®

 *Clickeá en el título para ir a la página*

MACROLED®

Línea bulbos	P.03	Paneles de gran formato & drivers	P.51
Línea bulbones Línea highpower	P.04	Accesorios paneles de gran formato	P.52
Línea DECO Línea golden Línea colors	P.07	Paneles COB	P.53
Línea PAR 30 / PAR 38	P.10	Paneles LED 6 a 24	P.54
Línea PAR16	P.11	 Listón T5	P.60
Línea AR111	P.13	SKYLINE	P.61
Línea PRO	P.14	Tortugas LED	P.79
Línea BIPIN	P.16	Estacas de jardín y solares	P.80
Guirnaldas	P.17	Luz de pared y de calle solar	P.81
Portalámparas aluminio	P.18	Reflectores LED PRO	P.84
Cables textiles	P.19	Reflectores LED	P.87
Portalámparas	P.20	 Reflectores TITÁN	P.89
Aros embutir MR16	P.21	Reflectores OLIMPUS	P.90
Artefactos MR16	P.22	Reflector 240 + HIGHBAY	P.91
Artefactos AR111	P.23	Luminaria pública y farolas	P.93
Artefactos MR16	P.24	Reflectores FOCUS	P.94
Artefactos embutir PC	P.25	Tiras LED	P.96
Artefacto plafón PC	P.26	Conectores	P.98
Artefactos de pared exterior	P.28	Controladoras	P.99
Línea SMART	P.29	inteck	
Línea ROMA	P.32	Cajas estancas	P.100
Línea TOKYO	P.34	Prolongadores	P.101
Teclas KINETIC	P.35	Precintos de nylon	P.102
Sensores SMART	P.36	Cintas aisladoras	P.103
Fotocélulas y sensores comunes	P.38	 Perfiles de PVC	P.104
Sensores comunes	P.39	Fichas y Tomas Industriales	P.105
Lámparas de mesa y pie	P.40	POWERSWITCH®	
Tubos LED	P.44	Fuentes Switching	P.111
Luminaria LED estanco listones para tubos	P.45	Fuentes Switching con riel DIN	P.112
Artefacto LED estanco	P.45		
Luces de emergencia Linterna PRO	P.47		
Señales luminosas	P.50		



A55 6.5W / E27 / 55X103mm					VIDA ÚTIL	MASTER
BT-55-7WW	220°	3000°K	690lm	106 lm/W	15.000hs	100u.
BT-55-7NW	220°	4500°K	690lm	106 lm/W	15.000hs	100u.
BT-55-7CW	220°	6500°K	690lm	106 lm/W	15.000hs	100u.



BULBO A60 9,5W / E27 / 60X113mm					VIDA ÚTIL	MASTER
BT-60-10WW	220°	3000°K	950lm	100 lm/W	15.000hs	100u.
BT-60-10NW	220°	4500°K	950lm	100 lm/W	15.000hs	100u.
BT-60-10CW	220°	6500°K	950lm	100 lm/W	15.000hs	100u.



BULBO A60 11,5W / E27 / 60X118mm					VIDA ÚTIL	MASTER
BT-60-12WW	220°	3000°K	1100lm	95,6 lm/W	15.000hs	100u.
BT-60-12NW	220°	4500°K	1100lm	95,6 lm/W	15.000hs	100u.
BT-60-12CW	220°	6500°K	1100lm	95,6 lm/W	15.000hs	100u.



BULBO A60 14,5W / E27 / 60X118mm					VIDA ÚTIL	MASTER
BT-60-15WW	220°	3000°K	1400lm	96,5 lm/W	15.000hs	100u.
BT-60-15NW	220°	4500°K	1400lm	96,5 lm/W	15.000hs	100u.
BT-60-15CW	220°	6500°K	1400lm	96,5 lm/W	15.000hs	100u.



PERFUME LED 1.8W / E14 / 18X25mm					VIDA ÚTIL	MASTER
BTF-1.8-14WW	360°	2700°K	140lm	77,7 lm/W	15000hs	100u./600u.
BTF-1.8-14CW	360°	6000°K	155lm	86,1 lm/W	15000hs	100u./600u.



PERFUME LED 3W / E14 / 18X25mm					VIDA ÚTIL	MASTER
BTF-4-14WW	360°	2700°K	270lm	90 lm/W	15000hs	100u./600u.
BTF-4-14CW	360°	6000°K	280lm	93,3 lm/W	15000hs	100u./600u.



GOTA G45 6W / E27 & E14 / 45X81mm					VIDA ÚTIL	MASTER
G45-6-E27-WW	200°	3000°K	520lm	86 lm/W	25.000hs	100u.
G45-6-E27-CW	200°	6000°K	520lm	86 lm/W	25.000hs	100u.
G45-6-E14-WW	200°	3000°K	520lm	86 lm/W	25.000hs	100u.
G45-6-E14-CW	200°	6000°K	520lm	86 lm/W	25.000hs	100u.



VELA C37 6W / E27 & E14 / 36,5X100mm					VIDA ÚTIL	MASTER
C37-6-E27-WW	200°	3000°K	520lm	86 lm/W	25.000hs	100u.
C37-6-E27-CW	200°	6000°K	520lm	86 lm/W	25.000hs	100u.
C37-6-E14-WW	200°	3000°K	520lm	86 lm/W	25.000hs	100u.
C37-6-E14-CW	200°	6000°K	520lm	86 lm/W	25.000hs	100u.



GLOBO G95 14W / E27 / 95X135mm					VIDA ÚTIL	MASTER
G95-14-E27-WW	200°	3000°K	1600lm	114 lm/W	25.000hs	20u.
G95-14-E27-CW	200°	6500°K	1600lm	114 lm/W	25.000hs	20u.



GLOBO G120 18W / E27 / 120X158mm					VIDA ÚTIL	MASTER
G120-18-E27-WW	200°	3000°K	2140lm	118,8 lm/W	25.000hs	20u.
G120-18-E27-CW	200°	6000°K	2140lm	118,8 lm/W	25.000hs	20u.



Vida Útil
9.000hs
8.000 ON/OFF

Iluminación Mejorada
90lm x watt

Factor Potencia
0.5
AC185-265V



Vida Útil
15.000hs
15.000 ON/OFF

Iluminación Mejorada
90lm x watt

Factor Potencia
0.9
AC175-265V



Vida Útil
15.000hs
15.000 ON/OFF

Iluminación Mejorada
100lm x watt

Factor Potencia
0.9
AC185-265V



BULBÓN 19W / E27 / 80X120mm						FP	VIDA ÚTIL	MASTER
C-BAP-20CW	180°	6500°K	1.710lm	90 lm/W	0.5	9000hs	50u.	



BULBÓN 28W / E27 / 100X152mm						FP	VIDA ÚTIL	MASTER
C-BAP-30CW	180°	6500°K	2.500lm	89,2lm/W	0.5	9000hs	40u.	



BULBÓN LED 38W / E27 / 120X168mm						FP	VIDA ÚTIL	MASTER
C-BAP-40CW	180°	6500°K	3.540lm	93,1lm/W	0.5	9000hs	20u.	



BULBÓN LED 48W / E27 / 140X191mm						FP	VIDA ÚTIL	MASTER
C-BAP-50CW	180°	6500°K	3.540lm	93,1lm/W	0.5	9000hs	20u.	



BULBÓN LED 60W / E40 / 140X208mm						FP	VIDA ÚTIL	MASTER
C-BAP-60-E40-CW	270°	6500°K	5.400lm	90lm/W	0.5	15.000 hs	20u.	



HIGHPOWER BULBON LED 20W / E27 / 80X147mm						FP	VIDA ÚTIL	MASTER
BAP-20-E27-WW	180°	3000°K	2000lm	100lm/W	0.9	15000hs	20u.	
BAP-20-E27-CW	180°	6500°K	2000lm	100lm/W	0.9	15000hs	20u.	



HIGHPOWER BULBON LED 30W / E27 / 100X188mm						FP	VIDA ÚTIL	MASTER
BAP-30-E27-WW	180°	3000°K	3000lm	100lm/W	0.9	15000hs	20u.	
BAP-30-E27-CW	180°	6500°K	3000lm	100lm/W	0.9	15000hs	20u.	



HIGHPOWER BULBON LED 40W / E27 / 120X220mm						FP	VIDA ÚTIL	MASTER
BAP-40-E27-WW	180°	3000°K	4000lm	100lm/W	0.9	15000hs	12u.	
BAP-40-E27-CW	180°	6500°K	4000lm	100lm/W	0.9	15000hs	12u.	



HIGHPOWER BULBON LED 60W / E27 / 120X275mm						FP	VIDA ÚTIL	MASTER
BAP-60-E27-WW	180°	3000°K	6000lm	100lm/W	0.9	15000hs	8u.	
BAP-60-E27-CW	180°	6500°K	6000lm	100lm/W	0.9	15000hs	8u.	



Vida Útil
25.000hs
2 años de garantía

**Disipador
abierto**
de Aluminio



**Iluminación
Mejorada**
100lm x watt

**Driver
Mejorado**
AC100-240V
PF 0.9

ADVERTENCIA: Para una óptima disipación del calor, las Magnolias deben ser instaladas verticalmente apuntando hacia arriba.



HIGHPOWER MAGNOLIA 40W / E27 / 90X215mm y 90x220mm						FP	VIDA ÚTIL	MASTER
BTM-40-E27WW	220°	3000°K	3800lm	95lmxw	0.9	25.000hs	10u.	
BM-40-E27-CW	300°	6500°K	4600lm	115lmxw	0.9	25.000hs	20u.	



HIGHPOWER MAGNOLIA 40W / E40 / 90X220mm						FP	VIDA ÚTIL	MASTER
BTM-40WW	200°	3000°K	3800lm	95lmxw	0.9	25.000hs	10u.	
BTM-40CW	200°	6000°K	4000lm	100lmxw	0.9	25.000hs	10u.	



HIGHPOWER MAGNOLIA 80W / E40 / 120X285mm						FP	VIDA ÚTIL	MASTER
BTM-80WW	200°	3000°K	8000lm	100lmxw	0.9	25.000hs	10u.	
BTM-80CW	200°	6000°K	8200lm	102,5lmxw	0.9	25.000hs	10u.	



HIGHPOWER BULBON LED 60W / E40 / 135X255mm						FP	VIDA ÚTIL	MASTER
BAP-60-E40-WW	200°	3000°K	6000lm	100lmxw	0.9	25.000hs	8u.	
BAP-60-E40-CW	200°	6500°K	6000lm	100lmxw	0.9	25.000hs	8u.	



HIGHPOWER BULBON LED 90W / E40 / 160X288mm						FP	VIDA ÚTIL	MASTER
BAP-90-E40-WW	200°	3000°K	9000lm	100lmxw	0.9	25.000hs	8u.	
BAP-90-E40-CW	200°	6500°K	9000lm	100lmxw	0.9	25.000hs	8u.	



LÍNEA DECO GOTA 0.65W / E27 / 80X45mm					VIDA ÚTIL	MASTER	VENTA MÍNIMA
BFS14-1WW	360°	2700°K	70lm	107,6lm/w	25.000hs	100u.	20u.
BFS14-1CW	360°	6000°K	70lm	107,6lm/w	25.000hs	100u.	20u.



LÍNEA DECO VELA 4W C37 / E14 / 35X100mm					VIDA ÚTIL	MASTER
BFC37-4WW	360°	2700°K	480lm	120 lm/W	25.000hs	50u.
BFC37-4CW	360°	6000°K	505lm	126 lm/W	25.000hs	50u.
BFC37-E27-4WW	360°	2700°K	490lm	122 lm/W	25.000hs	50u.
BFC37-E27-4CW	360°	6000°K	515lm	129 lm/W	25.000hs	50u.



LÍNEA DECO GOTA 4W G45 / E27 / 45X72mm					VIDA ÚTIL	MASTER
BFG45-E14-4WW	360°	2700°K	480lm	120 lm/W	25.000hs	50u.
BFG45-E14-4CW	360°	6000°K	540lm	135 lm/W	25.000hs	50u.
BFG45-4WW	360°	2700°K	470lm	117 lm/W	25.000hs	50u.
BFG45-4CW	360°	6000°K	530lm	132 lm/W	25.000hs	50u.



LÍNEA DECO BULBO 6W A60 / E27 / 60X105mm					VIDA ÚTIL	MASTER
BFA60-6WW	360°	2700°K	800lm	133 lm/W	25.000hs	50u.
BFA60-6CW	360°	6000°K	840lm	140 lm/W	25.000hs	50u.



LÍNEA DECO BULBO 8W A60 / E27 / 60X105mm					VIDA ÚTIL	MASTER
BFA60-8WW	360°	2700°K	940lm	117 lm/W	25.000hs	50u.
BFA60-8CW	360°	6000°K	1040lm	130 lm/W	25.000hs	50u.



LÍNEA DECO VINTAGE DIMERIZABLE 8W ST19 / E27 / 64X140mm					VIDA ÚTIL	MASTER
DBFST19-8WW	360°	2700°K	875lm	110 lm/W	25.000hs	50u.
DBFST19-8CW	360°	6000°K	875lm	110 lm/W	25.000hs	50u.



LÍNEA DECO GLOBO DIMERIZABLE 8W G125 / E27 / 125X180mm					VIDA ÚTIL	MASTER
DBFG125-8WW	360°	2700°K	920lm	115lm/W	25.000hs	20u.
DBFG125-8CW	360°	6000°K	920lm	115lm/W	25.000hs	20u.



LÍNEA GOLDEN GOTA S14 1W / E27 / 80X45mm					VIDA ÚTIL	MASTER
BFS14G-1WW	360°	2200°K	80lm	80lm/W	25.000hs	20u./100u.



LÍNEA GOLDEN BULBO A60 2W / E27 / 105X60mm					VIDA ÚTIL	MASTER
BFA60G-2WW	360°	2200°K	150lm	75lm/W	25.000hs	20u./100u.
LÍNEA GOLDEN BULBO A60 5W / E27 / 105X60mm					VIDA ÚTIL	MASTER
BFA60G-5WW	360°	2200°K	350lm	70lm/W	25.000hs	20u./100u.



LÍNEA GOLDEN VELA C37 3W / E27 / 100X35mm					VIDA ÚTIL	MASTER
BFC37G-3WW	360°	2200°K	240lm	80lm/W	25.000hs	20u./100u.



LÍNEA GOLDEN GOTA G45 3W / E27 / 78X45mm					VIDA ÚTIL	MASTER
BFG45G-3WW	360°	2200°K	240lm	80lm/W	25.000hs	20u./100u.



LÍNEA GOLDEN TUBO T30 2W / E27 / 30X150mm					VIDA ÚTIL	MASTER
BFT30G-2WW	360°	2200°K	160lm	80lm/W	25.000hs	20u./100u.
LÍNEA GOLDEN TUBO T30 5W / E27 / 30X150mm					VIDA ÚTIL	MASTER
BFT30G-5WW	360°	2200°K	260lm	52lm/W	25.000hs	50u.



LÍNEA GOLDEN TUBO T45 4W / E27 / 45X110mm					VIDA ÚTIL	MASTER
BFT45G-4WW	360°	2200°K	240lm	60lm/W	25.000hs	20u./100u.



LÍNEA GOLDEN VINTAGE ST19 2W / E27 / 146X64mm					VIDA ÚTIL	MASTER
BFST19G-2WW	360°	2200°K	150lm	75lm/W	25.000hs	20u./100u.
LÍNEA GOLDEN VINTAGE ST19 5W / E27 / 146X64mm					VIDA ÚTIL	MASTER
BFST19-5WW	360°	2200°K	260lm	52lm/W	25.000hs	50u.



LÍNEA GOLDEN GLOBO 5W / E27 / 125X175mm					VIDA ÚTIL	MASTER
BFG95G-5WW	360°	2200°K	260lm	52lm/W	25.000hs	24u.
BFG125-5WW	360°	2200°K	260lm	52lm/W	25.000hs	20u.



LÍNEA DECO COLOR GOTA 1W / E27 / 80X45mm				MATERIAL	VIDA ÚTIL	MASTER	VENTA MÍNIMA
BFS14-1A	360°	Azul	460 NM	Vidrio Translucido	25.000hs	100u.	20u.
BFS14-1R	360°	Rojo	625 NM	Vidrio Translucido	25.000hs	100u.	20u.
BFS14-1V	360°	Verde	520 NM	Vidrio Translucido	25.000hs	100u.	20u.
BFS14-1Y	360°	Amarillo	585 NM	Vidrio Translucido	25.000hs	100u.	20u.



LÍNEA DECO COLOR BULBO 4W / E27 / 60X105mm				MATERIAL	VIDA ÚTIL	MASTER	VENTA MÍNIMA
BFA60-4 A	360°	Azul	460 NM	Vidrio Translucido	25.000hs	100u.	10u.
BFA60-4 R	360°	Rojo	625 NM	Vidrio Translucido	25.000hs	100u.	10u.
BFA60-4 V	360°	Verde	520 NM	Vidrio Translucido	25.000hs	100u.	10u.
BFA60-4 Y	360°	Amarillo	585 NM	Vidrio Translucido	25.000hs	100u.	10u.



PAR 30 11W / IP65 / E27 / 92x86mm					VIDA ÚTIL	MASTER
PAR30-11-E27-WW	38°	2700°K	950lm	86 lm/W	25.000hs	20u.
PAR30-11-E27-CW	38°	6500°K	1000lm	90 lm/W	25.000hs	20u.



PAR 38 18W / IP65 / E27 / 120x135mm					VIDA ÚTIL	MASTER
PAR38-20-E27-WW	38°	2700°K	1400lm	77,7 lm/W	25.000hs	20u.
PAR38-20-E27-CW	38°	6500°K	1400lm	77,7 lm/W	25.000hs	20u.



PAR 30 30W / E27 / 95x125mm					VIDA ÚTIL	MASTER
PAR30-30WW	24°	2700°K	2750lm	91,6lm/W	40.000hs	20u.

NUEVO SKU, MISMO PRODUCTO



PAR16 5W PVC 120° / GU10 / Ø50x49mm					VIDA ÚTIL	MASTER	
◆	PAR16-PVCB-5W-120D-WW	120°	2700°K	540lm	108lm/W	25.000hs	100u.
◆	PAR16-PVCB-5W-120D-NW	120°	4500°K	540lm	108lm/W	25.000hs	100u.
◆	PAR16-PVCB-5W-120D-CW	120°	6500°K	540lm	108lm/W	25.000hs	100u.



PAR16 7W PVC / GU10 / 59x50x50mm					VIDA ÚTIL	MASTER	
	CPS-DP-GU10-20W	38°	2700°K	595lm	85lm/W	25.000hs	100u.
	CPS-DP-GU10-20N	38°	4500°K	595lm	85lm/W	25.000hs	100u.
	CPS-DP-GU10-20C	38°	6500°K	595lm	85lm/W	25.000hs	100u.



PAR16 7W PVC DIMERIZABLE / GU10 / 59x50x50mm					VIDA ÚTIL	MASTER	
◆	PAR16-PVCB-7W-38D-DIMWW	38°	2700°K	595lm	85lm/W	25.000hs	100u.
	CPS-DP-GU10-20DNW	38°	4500°K	595lm	85lm/W	25.000hs	100u.
	CPS-DP-GU10-20DCW	38°	6500°K	595lm	85lm/W	25.000hs	100u.



PAR16 7W PVC NEGRA / GU10 / 59x50x50mm					VIDA ÚTIL	MASTER	
◆	PAR16-PVCN-7W-38D-CW	38°	2700°K	595lm	85lm/W	25.000hs	100u.
◆	PAR16-PVCN-7W-38D-NW	38°	4500°K	595lm	85lm/W	25.000hs	100u.
◆	PAR16-PVCN-7W-38D-CW	38°	6500°K	595lm	85lm/W	25.000hs	100u.



Bridgelux
Led marca líder
en el mercado



6.5W

*Compatible con dimmer apto LED.



PAR16-AL-6.5W-DIM / GU10 / ø50x54mm					VIDA ÚTIL	INTER/MASTER
PAR16-AL-6.5W-DIM-12D	12°	2700°K	585lm	90 lm/W	50.000hs	20u. / 100u.
PAR16-AL-6.5W-DIM-24D	24°	2700°K	585lm	90 lm/W	50.000hs	20u. / 100u.
PAR16-AL-6.5W-DIM-36D	36°	2700°K	585lm	90 lm/W	50.000hs	20u. / 100u.



7.2W / 7W

*Compatible con dimmer apto LED.



PAR16-V-7W-36D / GU10 / ø50x54mm					VIDA ÚTIL	MASTER/VENTA MÍN.
PAR16-V-7W-36D-DIMWW	36°	2700°K	540lm	75 lm/W	15.000hs	10u. / 80u.
PAR16-V-7W-36D-DIMCW	36°	6500°K	540lm	75 lm/W	15.000hs	10u. / 80u.
PAR16-V-7W-36DWW	36°	2700°K	600lm	85 lm/W	25.000hs	10u. / 80u.
PAR16-V-7W-36DCW	36°	6500°K	600lm	85 lm/W	25.000hs	10u. / 80u.



Carcasa Premium
de Aluminio



AR111 11W PVC / GU10 / 111x65mm					VIDA ÚTIL	MASTER
ND111-11-WW	25°	2700°K	980lm	89 lm/W	25.000hs	50u.
ND111-11-CW	25°	6500°K	990lm	90 lm/W	25.000hs	50u.



AR111 11W PVC BLANCA / GU10 / 111x65mm					VIDA ÚTIL	MASTER
BND111-11-WW	25°	2700°K	980lm	89 lm/W	25.000hs	50u.
BND111-11-CW	25°	6500°K	990lm	90 lm/W	25.000hs	50u.



AR111 15W PVC / GU10 / 111x65mm					VIDA ÚTIL	MASTER
ND111-15-WW	25°	2700°K	980lm	89 lm/W	25.000hs	50u.
ND111-15-CW	25°	6500°K	990lm	90 lm/W	25.000hs	50u.



AR111 15W PVC BLANCA / GU10 / 111x65mm					VIDA ÚTIL	MASTER
BND111-15-WW	25°	2700°K	980lm	89 lm/W	25.000hs	50u.
BND111-15-CW	25°	6500°K	990lm	90 lm/W	25.000hs	50u.



AR111 15W PVC DIMERIZABLE / GU10 / 111x65mm					VIDA ÚTIL	MASTER
ES111-15-WW	25°	2700°K	980lm	89 lm/W	25.000hs	50u.
ES111-15-CW	25°	6500°K	990lm	90 lm/W	25.000hs	50u.



AR111 15W ALUMINIO DIMERIZABLE / GU10 / 111x61mm					VIDA ÚTIL	MASTER
D-111-GU10-WW	30°	2700°K	1380lm	92lm/W	40000hs	50u.
D-111-GU10-CW	30°	6500°K	1425lm	95lm/W	40000hs	50u.

MATERIAL

ACRÍLICO FOCAL
+ ALUMINIO



3 AÑOS GARANTÍA

Ángulo de Apertura
8°

24°

CRI ≥93Ra
Colores más vivos y con más intensidad.

LED BRIDGELUX
Con led Bridgelux, marca líder en el mercado.

SPD 3000V
Protección contra sobretensiones

Producto Dimerizable

Advertencias: La lámpara debe ser instalada verticalmente en artefactos abiertos en óptimas condiciones. *Compatible con dimmer apto LED

	AR111 PRO 11W DIMERIZABLE 8° / GU10 / 92x111mm					VIDA ÚTIL	MASTER
	AR111-12W-8-DIM-WW	Cálido	2700°K	600lm	54,5 lm/W	30000hs	20u.

	AR111 PRO 11W DIMERIZABLE 24° / GU10 / 92x111mm					VIDA ÚTIL	MASTER
	AR111-12W-24-DIM-WW	Cálido	2700°K	600lm	54,5 lm/W	30000hs	20u.

MATERIAL

PA+PC



2 AÑOS GARANTÍA

Ángulo de Apertura
12°

24°

Multivoltaje
AC100-240V

SPD 500V

Ángulo de Apertura	Tipo LED	Temperatura de color	DIM
12°	COB Samsung	2700	X
		4000	X
24°	SMD	2700	X
		4000	X
		2700	✓

	AR111-C-11W-12D / GU10 / ø110 x 75,5mm					VIDA ÚTIL	MASTER/VENTA_{MÍN.}
	AR111-C-11W-12DWW	Cálido	2700°K	950lm	86lm x/W	25000hs	4u. / 24u.
	AR111-C-11W-12DNW	Neutro	4000°K	950lm	86lm x/W	25000hs	4u. / 24u.

	AR111-FC-10W-24D / GU10 / ø110x75,5mm					VIDA ÚTIL	MASTER/VENTA_{MÍN.}
	AR111-FC-10W-24DWW	Cálido	2700°K	950lm	95lm x/W	25000hs	4u. / 24u.
	AR111-FC-10W-24DNW	Neutro	4000°K	950lm	95lm x/W	25000hs	4u. / 24u.

	AR111-DIM-FC-11W-24D / ø110 x 75,5mm					VIDA ÚTIL	MASTER/VENTA_{MÍN.}
	AR111-DIM-FC-11W-24DWW	Cálido	2700°K	950lm	86lm x/W	25000hs	4u. / 24u.

MATERIAL

ACRÍLICO FOCAL
+ ALUMINIO

Disipador
de Aluminio





Producto
Dimerizable*

2
AÑOS
GARANTÍA

Ángulo de
Apertura

12°

24°

CRI ≥93Ra
Colores más vivos y
con más intensidad.

LED BRIDGELUX
Con led Bridgelux, marca
líder en el mercado.

SPD 3000V
Protección contra
sobretensiones

Advertencias: La lámpara debe ser instalada verticalmente en artefactos abiertos en óptimas condiciones. *Compatible con dimmer apto LED



MR16 PRO 5W DIMERIZABLE 12° / GU10 / 64x49mm					VIDA ÚTIL	MASTER
MR16-5W-12G-DIM-WW	Cálido	2700°K	250lm	50 lm/W	30000hs	50u.



MR16 PRO 5W DIMERIZABLE 24° / GU10 / 64x49mm					VIDA ÚTIL	MASTER
MR16-5W-24G-DIM-WW	Cálido	2700°K	250lm	50 lm/W	30000hs	50u.



BIPIN G9 4,5W / 15X50mm					VIDA ÚTIL	INTER / MASTER
G9-4.5-WW	360°	2700°K	390lm	86 lm/W	25.000hs	100u. / 600u.
G9-4.5-CW	360°	6000°K	390lm	86 lm/W	25.000hs	100u. / 600u.



BIPIN G9 6W / 15X60mm					VIDA ÚTIL	INTER / MASTER
G9-6-WW	360°	2700°K	570lm	95 lm/W	25.000hs	100u. / 600u.
G9-6-CW	360°	6000°K	570lm	95 lm/W	25.000hs	100u. / 600u.



BIPIN G9 9W / 20X64mm					VIDA ÚTIL	INTER / MASTER
G9-9-WW	360°	2700°K	900lm	100 lm/W	25.000hs	100u. / 400u.
G9-9-CW	360°	6000°K	900lm	100 lm/W	25.000hs	100u. / 400u.



BIPIN G9 12W / 24X66mm					VIDA ÚTIL	INTER / MASTER
G9-12WW	360°	2700°K	1200lm	100 lm/W	25.000hs	100u. / 400u.
G9-12CW	360°	6000°K	1200lm	100 lm/W	25.000hs	100u. / 400u.



BIPIN G4 2W / 12V / 16x36mm					VIDA ÚTIL	INTER / MASTER
G4-2WW	360°	2700°K	200lm	100 lm/W	25.000hs	100u. / 600u.
G4-2CW	360°	6000°K	200lm	100 lm/W	25.000hs	100u. / 600u.



BIPIN G4 4W / 12V / 16x56mm					VIDA ÚTIL	INTER / MASTER
G4-4WW	360°	2700°K	420lm	105 lm/W	25.000hs	100u. / 600u.
G4-4CW	360°	6000°K	420lm	105 lm/W	25.000hs	100u. / 600u.



BIPIN G9 5W OPAL / 16x60mm					VIDA ÚTIL	INTER / MASTER
G9-OP-5-WW	360°	2700°K	460lm	92 lm/W	25.000hs	100u. / 600u.
G9-OP-5-CW	360°	6000°K	460lm	92 lm/W	25.000hs	100u. / 600u.



BIPIN G4 2,5W OPAL / 220V-240V / 16x45mm					VIDA ÚTIL	INTER / MASTER
G4-OP-220-2.5-WW	360°	2700°K	190lm	76 lm/W	25.000hs	100u./1000u.
G4-OP-220-2.5-CW	360°	6000°K	190lm	76 lm/W	25.000hs	100u./1000u.



GUIRNALDA LARGA E27	LARGO	CANT. DE CONECTORES	POTENCIA	PROTECCIÓN	MASTER
GUIR-5MT-E27	5 m.	10	700W Máx.	IP66	10u.
GUIR-10MT-E27	10 m.	20	700W Máx.	IP66	8u.

GUIRNALDA CORTA E27	LARGO	CANT. DE CONECTORES	POTENCIA	PROTECCIÓN	MASTER
GUIRC-5MT-E27	5 m.	10	700W Máx.	IP66	10u.
GUIRC-10MT-E27	10 m.	20	700W Máx.	IP66	8u.



VINTAGE



VINTAGE/
CON PERILLA



JERSEY



NASHVILLE



DIXON



VANCOUVER



Portalámparas Nashville E27		POTENCIA MÁX	CONECTOR	TENSIÓN	MASTER	VENTA MIN.
PLV-NAS-E27-CO	Cobre	60W Máx.	E27	250V Máx.	100u.	10u.
PLV-NAS-E27-BR	Bronce	60W Máx.	E27	250V Máx.	100u.	10u.
PLV-NAS-E27-BB	Bronce Brillante	60W Máx.	E27	250V Máx.	100u.	10u.



Portalámparas Vintage E27		POTENCIA MÁX	CONECTOR	TENSIÓN	MASTER	VENTA MIN.
PLV-VIN-E27-CO	Cobre	60W Máx.	E27	250V Máx.	100u.	10u.
PLV-VIN-E27-BR	Bronce	60W Máx.	E27	250V Máx.	100u.	10u.
PLV-VIN-E27-BB	Bronce Brillante	60W Máx.	E27	250V Máx.	100u.	10u.



Portalámparas Vintage con Perilla E27		POTENCIA MÁX	CONECTOR	TENSIÓN	MASTER	VENTA MIN.
PLV-VIN-P-E27-CO	Cobre	60W Máx.	E27	250V Máx.	100u.	10u.
PLV-VIN-P-E27-BR	Bronce	60W Máx.	E27	250V Máx.	100u.	10u.
PLV-VIN-P-E27-BB	Bronce Brillante	60W Máx.	E27	250V Máx.	100u.	10u.



Portalámparas Dixon E27		POTENCIA MÁX	CONECTOR	TENSIÓN	MASTER	VENTA MIN.
PLV-DIX-E27-CO	Cobre	60W Máx.	E27	250V Máx.	100u.	10u.
PLV-DIX-E27-BR	Bronce	60W Máx.	E27	250V Máx.	100u.	10u.
PLV-DIX-E27-BB	Bronce Brillante	60W Máx.	E27	250V Máx.	100u.	10u.



Portalámparas Jersey E27		POTENCIA MÁX	CONECTOR	TENSIÓN	MASTER	VENTA MIN.
PLV-JER-E27-CO	Cobre	60W Máx.	E27	250V Máx.	100u.	10u.
PLV-JER-E27-BR	Bronce	60W Máx.	E27	250V Máx.	100u.	10u.
PLV-JER-E27-BB	Bronce Brillante	60W Máx.	E27	250V Máx.	100u.	10u.



Portalámparas Vancouver E27		POTENCIA MÁX	CONECTOR	TENSIÓN	MASTER	VENTA MIN.
PLV-VAN-E27-NE	Negro	60W Máx.	E27	250V Máx.	100u.	10u.
PLV-VAN-E27-CR	Cromo	60W Máx.	E27	250V Máx.	100u.	10u.
PLV-VAN-E27-CO	Cobre	60W Máx.	E27	250V Máx.	100u.	10u.



CAB-TEX-BM-100



CAB-TEX-MG-100



CAB-TEX-BN-100



CAB-TEX-ND-50



CAB-TEX-AN-100



CAB-TEX-BR-100



CAB-TEX-DD-50

Todos los modelos de cables textiles, son productos normalizados.

Cables Textiles	SECCIÓN	TENSIÓN	CARRETEL xMTS	COLOR	VENTA MINIMA
CAB-TEX-BM-100	0,5MM2	300V	x100	Blanco Marfil	1u.
CAB-TEX-BR-100	0,5MM2	300V	x100	Bronce	1u.
CAB-TEX-ND-50	0,5MM2	300V	x50	Negro con Dorado Zig Zag	1u.
CAB-TEX-MG-100	0,5MM2	300V	x100	Manteca con Gris	1u.
CAB-TEX-BN-100	0,5MM2	300V	x100	Blanco y Negro Zig Zag	1u.
CAB-TEX-AN-100	0,5MM2	300V	x100	Arpillera con Negro Zig Zag	1u.
CAB-TEX-DD-50	0,5MM2	300V	x50	Dorado	1u.



PL-E27



PL-E27-ES



PL-E27-PU



PL-E27-RO



PL-E40



GU5.3



GU9 / CON CABLE



K512GU

Portalámparas Cerámico E27	CARACTERÍSTICAS	POTENCIA MÁX.	CONECTOR	TENSIÓN	MASTER	VENTA MIN.
PL-E27	-	1000W Máx.	E27	250V Máx.	100u.	20u.
PL-E27-PU	Con Puente	1000W Máx.	E27	250V Máx.	100u.	20u.
PL-E27-ES	Con Escuadra	1000W Máx.	E27	250V Máx.	100u.	20u.

Portalámparas Plástico E27	CARACTERÍSTICAS	POTENCIA MÁX.	CONECTOR	TENSIÓN	MASTER	VENTA MIN.
PL-E27-RO	Rosca Exterior con Aro	60W Máx.	E27	750V Máx.	100u.	20u.

Portalámparas Cerámico E40	CARACTERÍSTICAS	POTENCIA MÁX.	CONECTOR	TENSIÓN	MASTER	VENTA MIN.
PL-E40	-	3000W Máx.	E40	250V Máx.	100u.	20u.

Conector Cerámico GU5.3	CARACTERÍSTICAS	POTENCIA MÁX.	CONECTOR	TENSIÓN	MASTER	VENTA MIN.
CON-GU5.3-CAB	Cable Entelado (15cm)	40W Máx.	GU5.3	250V Máx.	500u.	20u.

Portalámparas Cerámico G9	CARACTERÍSTICAS	POTENCIA MÁX.	CONECTOR	TENSIÓN	MASTER	VENTA MIN.
CON-G9	-	100W Máx.	G9	250V Máx.	500u.	50u.
CON-G9-CAB	Con Cable (15cm)	100W Máx.	G9	250V Máx.	500u.	50u.

Conector Cerámico GU10	CARACTERÍSTICAS	POTENCIA MÁX.	CONECTOR	TENSIÓN	MASTER
K512GU	Cable Entelado (20cm)	100W Máx.	GU10	750V Máx.	500u.

MATERIAL

METAL



Artefactos compatibles con lámparas de Ø50 mm.

EMBUTIR MR16 FIJO 8mm	COLOR	LÁMPARAS	DIMENSION	CORTE	MASTER
ADF-D8-BCO	● Blanco	DICRO 50mm	Ø80mm	Ø60mm	200u.

EMBUTIR MR16 MÓVIL 8mm	COLOR	LÁMPARAS	DIMENSION	CORTE	MASTER
ADM-D8-BCO	● Blanco	DICRO 50mm	Ø83mm	Ø65mm	100u.
ADM-D8-NEG	● Negro	DICRO 50mm	Ø83mm	Ø65mm	100u.
ADM-D8-PLA	● Platil	DICRO 50mm	Ø83mm	Ø65mm	100u.

EMBUTIR MR16 MÓVIL 10mm	COLOR	LÁMPARAS	DIMENSION	CORTE	MASTER
ADM-D10-BCO	● Blanco	DICRO 50mm	Ø100mm	Ø80mm	100u.
ADM-D10-NEG	● Negro	DICRO 50mm	Ø100mm	Ø80mm	100u.
ADM-D10-PLA	● Platil	DICRO 50mm	Ø100mm	Ø80mm	100u.

MATERIAL

ALUMINIO



EMBUTIR ALUMINIO IP54	COLOR	COMPATIBILIDAD	DIMENSION	CORTE	INTER / MASTER
AERD-X1-B-ALU-IP54	● Blanco	Circular	Ø85x30mm	Ø60mm	10u. / 100u.

ANTIDESLUMBRANTE FIJO	COLOR	COMPATIBILIDAD	DIMENSION	CORTE	INTER / MASTER
AECADF-X1-BC-ALU	● Blanco	Cuadrado	93x93x35mm	Ø80mm	10u. / 100u.
AERADF-X1-BC-ALU	○ Blanco	Circular	93x93x35mm	Ø80mm	10u. / 100u.

EMBUTIR ALUMINIO MÓVIL	COLOR	COMPATIBILIDAD	DIMENSION	CORTE	INTER / MASTER
AECD-X1-B-ALU	● Blanco	Cuadrado	94x94x25mm	Ø75mm	10u. / 100u.
AERD-X1-B-ALU	● Blanco	Circular	Ø94x25mm	Ø75mm	10u. / 100u.

MATERIAL
METAL



- Móvil de 1 eje
- Fácil de Colocar
- Embutidos con guía para colocar
- Acabado satinado

Artefactos compatibles con lámparas de Ø50 mm.

EMBUTIR MÓVIL MR16	SPOT	COMPATIBLE	DIMENSIONES	CORTE	MASTER	
AED-X1-MB	● Blanco	x1	DICRO	100x100x37	85x85	50u.
AED-X1-MN	● Negro	x1	DICRO	100x100x37	85x85	50u.
AED-X2-MB	● Blanco	x2	DICRO	185x100x37	170x85	20u.
AED-X2-MN	● Negro	x2	DICRO	185x100x37	170x85	20u.
AED-X3-MB	● Blanco	x3	DICRO	270x100x37	255x85	20u.
AED-X3-MN	● Negro	x3	DICRO	270x100x37	255x85	20u.

MATERIAL
METAL



- Plafón Compatible con cajas octogonales homologadas chicas 8cm y grandes 10cm

PLAFÓN CARDANICO MR16	SPOT	COMPATIBLE	DIMENSIONES	MASTER	
APCD-X1-CB	● Blanco	x1	DICRO	134x134x106	20u.
APCD-X1-CN	● Negro	x1	DICRO	134x134x106	20u.
APCD-X2-CB	● Blanco	x2	DICRO	228x135x100	12u.
APCD-X2-CN	● Negro	x2	DICRO	228x135x100	12u.
APCD-X4-CB	● Blanco	x4	DICRO	225x225x106	6u.
APCD-X4-CN	● Negro	x4	DICRO	225x225x106	6u.

MATERIAL
METAL



- Doble Direccionamiento
- Fácil de Colocar
- Embutidos con guia para colocar
- Acabado satinado

Artefactos compatibles con lámparas de Ø111 mm.

EMBTIR CARDANICO AR111		SPOT	COMPATIBLE	DIMENSIONES	CORTE	MASTER
AECAR-X1-MB	● Blanco	x1	AR111	182x182x40	165x165	20u.
AECAR-X1-MN	● Negro	x1	AR111	182x182x40	165x165	20u.
AECAR-X2-MB	● Blanco	x2	AR111	182x332x40	165x300	12u.
AECAR-X2-MN	● Negro	x2	AR111	185x100x37	165x300	12u.
AECAR-X3-MB	● Blanco	x3	AR111	182x482x40	178x475	12u.
AECAR-X3-MN	● Negro	x3	AR111	182x482x40	178x475	12u.

MATERIAL
METAL



- Plafón Compatible con cajas octogonales homologadas chicas 8cm y grandes 10cm

PLAFÓN CARDANICO AR111		SPOT	COMPATIBLE	DIMENSIONES	MASTER
APCAR-X1-CB	● Blanco	x1	AR111	185x185x115	12u.
APCAR-X1-CN	● Negro	x1	AR111	185x185x115	12u.
APCAR-X2-CB	● Blanco	x2	AR111	335x185x115	8u.
APCAR-X2-CN	● Negro	x2	AR111	335x185x115	8u.
APCAR-X4-CB	● Blanco	x4	AR111	335x335x115	6u.
APCAR-X4-CN	● Negro	x4	AR111	335x335x115	6u.

MATERIAL

PC



AERAD-X1-BB-PC



AERAD-X1-NN-PC



AERAD-X1-BC-PC



AERAD-X1-NC-PC



AERAD-X1-BC-PC

Artefactos compatibles con lámparas de Ø50 mm.

ANTIDESLUMBRANTE MOVIL PC	COMPATIBLE	DIMENSIONES	CORTE	INTER / MASTER	
AERAD-X1-BB-PC	● ● Blanco-Blanco	1xGU10	85*85*32	Ø75	20u. / 100u.
AERAD-X1-BN-PC	○ ● Blanco-Negro	1xGU10	85*85*32	Ø75	20u. / 100u.
AERAD-X1-NN-PC	● ● Negro-Negro	1xGU10	85*85*32	Ø75	20u. / 100u.
AERAD-X1-BC-PC	○ ● Blanco-Cromo	1xGU10	85*85*32	Ø75	20u. / 100u.
AERAD-X1-NC-PC	● ● Negro-Cromo	1xGU10	85*85*32	Ø75	20u. / 100u.

MATERIAL

PC



AERADFR-X1-B-PC



AERAD-X1-BB-PC-TEX



AERADFC-X1-B-PC



AERDAC-X1-B-PC



AERDAC-X1-N-PC



AERDF-X1-B-PC



AERD-X1-B-PC

MOVIL PC	COMPATIBLE	DIMENSIONES	CORTE	INTER / MASTER	
AERD-X1-B-PC	● Blanco	1xGU10	Ø90*25	Ø75	20u. / 100u.

ANTIDESLUMBRANTE MOVIL PVC TEXTURADO	COMPATIBLE	DIMENSIONES	CORTE	INTER / MASTER	
AERAD-X1-BB-PC-TEX	● Blanco	1xGU10	Ø90*34	Ø75	20u. / 100u.

MOVIL PC FRENTE	COMPATIBLE	DIMENSIONES	CORTE	INTER / MASTER	
AERDF-X1-B-PC	● Blanco	1xGU10	Ø86*40	Ø50	20u. / 100u.

ANTIDESLUMBRANTE FIJO PC CURVO	COMPATIBLE	DIMENSIONES	CORTE	INTER / MASTER	
AERADFC-X1-B-PC	● Blanco	1xGU10	Ø86*40	Ø50	20u. / 100u.

ANTIDESLUMBRANTE FIJO PC RECTO	COMPATIBLE	DIMENSIONES	CORTE	INTER / MASTER	
AERADFR-X1-B-PC	● Blanco	1xGU10	Ø86*40	Ø85*35	20u. / 100u.

MOVIL PC ANGULO CERRADO	COMPATIBLE	DIMENSIONES	CORTE	INTER / MASTER	
AERDAC-X1-B-PC	● Blanco	1xGU10	Ø88*32	Ø75	20u. / 100u.
AERDAC-X1-N-PC	● Negro	1xGU10	Ø88*32	Ø75	20u. / 100u.



MATERIAL

PC



Artefactos compatibles con lámparas de Ø50 mm.

ANTIDESLUMBRANTE MOVIL PC	COMPATIBLE	DIMENSIONES	CORTE	INTER / MASTER	
AECAD-X2-B-PC	● Blanco	2xGU10	220*113*34	100*200	10u. / 50u.
AECAD-X2-N-PC	● Negro	2xGU10	220*113*34	100*200	10u. / 50u.
AECAD-X3-B-PC	● Blanco	3xGU10	326*113*34	100*300	5u. / 50u.
AECAD-X3-N-PC	● Negro	3xGU10	326*113*34	100*300	5u. / 50u.

MATERIAL

PC



EMBUTIR CUADRADO MÓVIL PC	COMPATIBLE	DIMENSIONES	CORTE	INTER / MASTER	
AECD-X1-B-PC	● Blanco	1xGU10	93*93*25	Ø75	20u. / 100u.
AECD-X2-B-PC	● Blanco	2xGU10	173x93x25	Ø75	10u. / 50u.
AECD-X2-N-PC	● Negro	2xGU10	173x93x25	Ø75	10u. / 50u.
AECD-X3-B-PC	● Blanco	3xGU10	252x93x25	Ø75	5u. / 50u.
AECD-X3-N-PC	● Negro	3xGU10	252x93x25	Ø75	5u. / 50u.

MATERIAL

PC

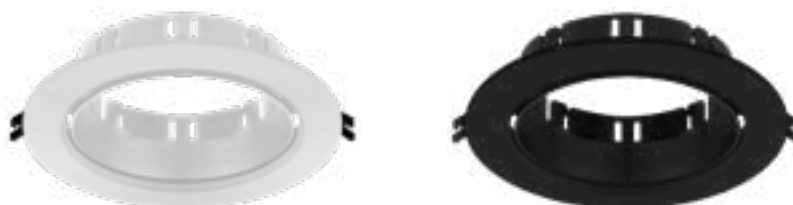

ANTIDESLUMBRANTE MÓVIL 1 EJE PC / REDONDO	COMPATIBLE	DIMENSIONES	CORTE	INTER / MASTER	
AERA-AR-X1-B-PC	● Blanco	1xAR111	165*165*43	135*155	10u. / 40u.
AERA-AR-X1-N-PC	● Negro	1xAR111	165*165*43	135*155	10u. / 40u.

MATERIAL

PC

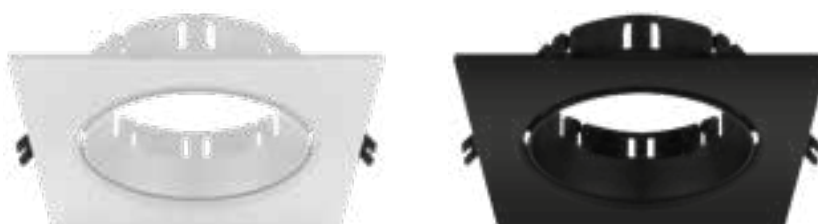

ANTIDESLUMBRANTE MÓVIL 1 EJE PC / CUADRADO	COMPATIBLE	DIMENSIONES	CORTE	INTER / MASTER	
AECA-AR-X1-B-PC	● Blanco	1xAR111	165*165*41	135*155	10u. / 40u.
AECA-AR-X1-N-PC	● Negro	1xAR111	165*165*41	135*155	10u. / 40u.

MATERIAL

PC



Artefactos compatibles con lámparas de Ø50 mm.

PLAFÓN LISO PC		FORMA	COMPATIBLE	DIMENSIONES	CORTE	INTER / MASTER
APCDL-X1-B-PC	● Blanco	Cuadrado	1xGU10	96*96*100	Ø50	10u. / 50u.
APRDL-X1-B-PC	○ Blanco	Redondo	1xGU10	96*96*100	Ø50	10u. / 50u.
APCDL-X1-N-PC	● Negro	Cuadrado	1xGU10	96*96*100	Ø50	10u. / 50u.
APRDL-X1-N-PC	● Negro	Redondo	1xGU10	96*96*100	Ø50	10u. / 50u.
APCDL-X2-B-PC	● Blanco	Cuadrado	2xGU10	186*98*100	Ø50	5u. / 20u.
APRDL-X2-B-PC	○ Blanco	Redondo	2xGU10	186*98*100	Ø50	5u. / 20u.
APCDL-X2-N-PC	● Negro	Cuadrado	2xGU10	186*98*100	Ø50	5u. / 20u.
APRDL-X2-N-PC	● Negro	Redondo	2xGU10	186*98*100	Ø50	5u. / 20u.

MATERIAL

PC



PLAFÓN RANURADO PC		FORMA	COMPATIBLE	DIMENSIONES	CORTE	INTER / MASTER
APCDR-X1-B-PC	● Blanco	Cuadrado	1xGU10	96*96*100	Ø50	10u. / 50u.
APRDR-X1-B-PC	○ Blanco	Redondo	1xGU10	96*96*100	Ø50	10u. / 50u.
APCDR-X1-N-PC	● Negro	Cuadrado	1xGU10	96*96*100	Ø50	10u. / 50u.
APRDR-X1-N-PC	● Negro	Redondo	1xGU10	96*96*100	Ø50	10u. / 50u.
APCDR-X2-B-PC	● Blanco	Cuadrado	2xGU10	186*98*100	Ø50	5u. / 20u.
APRDR-X2-B-PC	Blanco	Redondo	2xGU10	186*98*100	Ø50	5u. / 20u.
APCDR-X2-N-PC	● Negro	Cuadrado	2xGU10	186*98*100	Ø50	5u. / 20u.
APRDR-X2-N-PC	● Negro	Redondo	2xGU10	186*98*100	Ø50	5u. / 20u.

MATERIAL

LENTE: PC

CUERPO: ABS+ PC



Protección IP54



Iluminación Unidireccional

ARTEFACTO DE PARED UNIDIRECCIONAL		SPOT	COMPATIBLE	DIMENSIONES	MASTER	
AECN-X1	● Negro	Cuadrado	x1	GU10/MR16	162x90x113	16u.
AECB-X1	○ Blanco	Cuadrado	x1	GU10/MR16	162x90x113	16u.
AERN-X1	● Negro	Redondo	x1	GU10/MR16	162x90x113	16u.
AERB-X1	○ Blanco	Redondo	x1	GU10/MR16	162x90x113	16u.

MATERIAL

LENTE: PC

CUERPO: ABS+ PC



Protección IP54



Iluminación Bidireccional

ARTEFACTO DE PARED BIDIRECCIONAL		SPOT	COMPATIBLE	DIMENSIONES	MASTER	
AECN-X2	● Negro	Cuadrado	x2	GU10/MR16	215x90x113	16u.
AECB-X2	○ Blanco	Cuadrado	x2	GU10/MR16	215x90x113	16u.
AERN-X2	● Negro	Redondo	x2	GU10/MR16	215x90x113	16u.
AERB-X2	○ Blanco	Redondo	x2	GU10/MR16	215x90x113	16u.

MATERIAL

PC



Protección IP54



Iluminación Unidireccional

ARTEFACTO DE PARED LED INTEGRADO					DIMENSIONES	MASTER
AECN-3W	● Negro	Cálido	2700°K	460lm	120x32x120	24u.
AECB-3W	○ Blanco	Cálido	2700°K	460lm	120x32x120	24u.

Multicolor RGB + Blancos



Control por Voz

Controla todos tus dispositivos mediante los asistentes de voz Alexa®, Siri® o Google Assistant®.



Programación ON/OFF

Programa tus dispositivos para que prendan o apaguen, cuándo y cómo vos quieras mediante nuestra App.



DIY de escenas

Programas combinaciones de dispositivos con distintas tonalidades y funciones.



Garantía y Asistencia

2 años de Garantía por defectos de fabricación y asistencia gratuita por redes sociales.



BULBO LED A60 12W SMART RGB+W / E27 / Ø60x122mm				VIDA ÚTIL	MASTER	VENTA MIN.
SBT-A60-12W-RGB	Cálido	Frío	RGB 400-700mm	20000hs	100u.	10u.



DICROICA LED 5W Smart RGB+W / GU10 / Ø50x54mm				VIDA ÚTIL	MASTER	VENTA MIN.
SDL-MR16-5W-RGB	Cálido	Frío	RGB 400-700mm	20000hs	100u.	10u.

Multicolor RGB + Blancos



Control por Voz

Controla todos tus dispositivos mediante los asistentes de voz Alexa®, Siri® o Google Assistant®.



Programación ON/OFF

Programa tus dispositivos para que prendan o apaguen, cuándo y cómo vos quieras mediante nuestra App.



DIY de escenas

Programas combinaciones de dispositivos con distintas tonalidades y funciones.



Garantía y Asistencia

2 años de Garantía por defectos de fabricación y asistencia gratuita por redes sociales.



REFLECTOR 20W SMART RGB+W / IP65 / 209x168x30mm				VIDA ÚTIL	MASTER	VENTA MIN.
SMA-FLSV2-20RGBWW	Cálido	Frío	RGB 400-700mm	20000hs	20u.	5u.



REFLECTOR 50W SMART RGB+W / IP65 / 237x200x36mm				VIDA ÚTIL	MASTER	VENTA MIN.
SMA-FLSV2-50RGBWW	Cálido	Frío	RGB 400-700mm	20000hs	12u.	3u.



Control por Voz

Controla todos tus dispositivos mediante los asistentes de voz Alexa®, Siri® o Google Assistant®.



DIY de escenas

Programas combinaciones de dispositivos con distintas tonalidades y funciones.



Programación ON/OFF

Programa tus dispositivos para que prendan o apaguen, cuándo y cómo vos quieras mediante nuestra App.



Garantía y Asistencia

2 años de Garantía por defectos de fabricación y asistencia gratuita por redes sociales.



ENCHUFE SMART / 118x72x39mm	CORRIENTE	SPD	TENSIÓN	MASTER	VENTA MIN.
ESX1-2073	2200W máx.	10A máx.	AC2000V	100u.	1u.

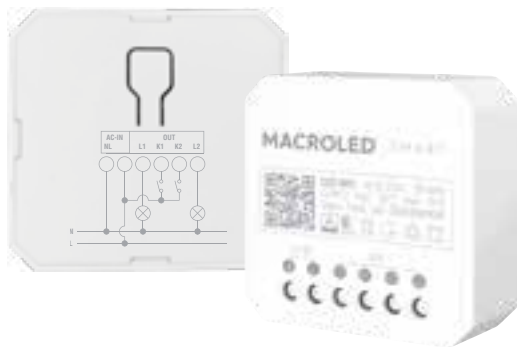

Control por Voz

Controla todos tus dispositivos mediante los asistentes de voz Alexa®, Siri® o Google Assistant®.



DIY de escenas

Programas combinaciones de dispositivos con distintas tonalidades y funciones.



Programación ON/OFF

Programa tus dispositivos para que prendan o apaguen, cuándo y cómo vos quieras mediante nuestra App.



Garantía y Asistencia

2 años de Garantía por defectos de fabricación y asistencia gratuita por redes sociales.



INTERRUPTOR SMART / 45x44x17mm	CORRIENTE	CABLEADO	TENSIÓN	MASTER	VENTA MIN.
SSX2-WIFI	150W*2	5A*2	0.75-1.0mm2	200u.	1u.

TECLAS SMART

MATERIAL

PC+VIDRIO



Bluetooth



Wi-Fi

TECLAS VIDRIO SMART TOUCH / 118x72x39mm		CORRIENTE	TENSIÓN	MASTER	VENTA MIN.
TSX1B	● Blanco x1 Canal	10A máx.	AC100-240V	40u.	1u.
TSX1N	● Negro x1 Canal	10A máx.	AC100-240V	40u.	1u.
TSX2B	● Blanco x2 Canales	10A máx.	AC100-240V	40u.	1u.
TSX2N	● Negro x2 Canales	10A máx.	AC100-240V	40u.	1u.

MATERIAL

PC+VIDRIO

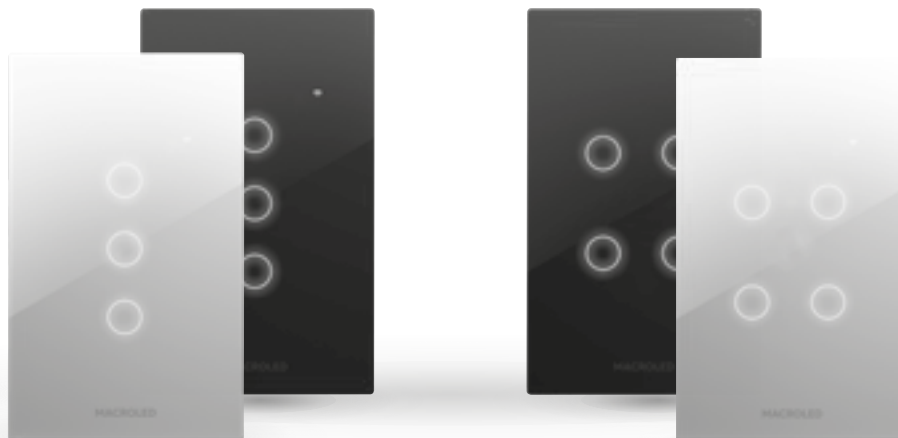

TECLAS VIDRIO SMART TOUCH / 120x80x36mm		CORRIENTE	TENSIÓN	MASTER	VENTA MIN.
TSX3B-CP	* ● Blanco x3 Canales	7A máx.	AC100-240V	40u.	1u.
TSX3N-CP	* ● Negro x3 Canales	7A máx.	AC100-240V	40u.	1u.
TSX4B-CP	* ● Blanco x4 Canales	7A máx.	AC100-240V	40u.	1u.
TSX4N-CP	* ● Negro x4 Canales	7A máx.	AC100-240V	40u.	1u.

MATERIAL

PC+VIDRIO



TECLA VIDRIO SMART DIMERIZABLE / 120x80x36mm		CORRIENTE	TENSIÓN	MASTER	VENTA MIN
DIM-TSX1B	● Blanco	10A máx.	AC100-240V	40u.	1u.
DIM-TSX1N	● Negro	10A máx.	AC100-240V	40u.	1u.

MATERIAL

PC+VIDRIO



TSPB



TSPN



Bluetooth



Wi-Fi



TECLA VIDRIO SMART PERSIANA / 120x80x36mm	CORRIENTE	TENSIÓN	MASTER	VENTA MIN.	
TSPB	● Blanco	2A máx.	AC100-240V	40u.	1u.
TSPN	● Negro	2A máx.	AC100-240V	40u.	1u.

MATERIAL

PC



TS-P1B-CP/TS-P1N-CP

TS-P2B-CP/TS-P2N-CP

TS-P3B-CP/TS-P3N-CP

TS-P4B-CP/TS-P4N-CP



TECLAS PULSADOR SMART / 120x80x43mm		CORRIENTE	TENSIÓN	MASTER	VENTA MIN.
TS-P1B-CP	● Blanco x1 Canal	7A máx.	AC100-240V	40u.	1u.
TS-P1N-CP	● Negro x1 Canal	7A máx.	AC100-240V	40u.	1u.
TS-P2B-CP	● Blanco x2 Canales	7A máx.	AC100-240V	40u.	1u.
TS-P2N-CP	● Negro x2 Canales	7A máx.	AC100-240V	40u.	1u.
TS-P3B-CP	● Blanco x3 Canales	7A máx.	AC100-240V	40u.	1u.
TS-P3N-CP	● Negro x3 Canales	7A máx.	AC100-240V	40u.	1u.
TS-P4B-CP	● Blanco x4 Canales	7A máx.	AC100-240V	40u.	1u.
TS-P4N-CP	● Negro x4 Canales	7A máx.	AC100-240V	40u.	1u.

MATERIAL

PC



TK-P1B-RF

TK-P2B-RF

TK-P3B-RF



Alcance Máx.
100m Espacio Abierto/
30m Espacio Cerrado

TECLA PULSADOR / 86x86x16.5mm	ALIMENTACIÓN	TRANSMISIÓN	MASTER	VENTA MIN.	
TK-P1B-RF	● Blanco x1 Canal RF	Autoalimentación por Energía Cinética	Radio Frec.	175u.	1u.
TK-P2B-RF	○ Blanco x2 Canales RF	Autoalimentación por Energía Cinética	Radio Frec.	175u.	1u.
TK-P3B-RF	● Blanco x3 Canales RF	Autoalimentación por Energía Cinética	Radio Frec.	175u.	1u.

MATERIAL

ABS+PC



CON-K-RF



Bluetooth



Wi-Fi



Radio Frecuencia

CON-K-RFWIFI



CONTROLADORAS		CORRIENTE	TENSIÓN	MASTER	VENTA MIN.
CON-K-RF	Radio Frecuencia	10A máx.	AC100-240V	278u.	1u.
CON-K-RFWIFI	Radio Frecuencia y Smart	16A máx.	AC100-240V	278u.	1u.



SMSTB-360-5M-BL



SMSTB-360-5M-3AAA



SMSPB-110-8M-3AAA



SENSORES DE MOVIMIENTO	BATERÍA	ÁNGULO	DISTANCIA MÁX	INTER. /MASTER	VENTA MIN.
SMSTB-360-5M-BL	Litio Recargable USB	360°	5m	10u. / 200u.	10u.
SMSTB-360-5M-3AAA	Alkalina 3x AAA	360°	5m	10u. / 200u.	10u.
SMSPB-110-8M-3AAA	Alkalina 3x AAA	110° hor./ver.	8m	10u. / 200u.	10u.



x2 Baterías Alkalinas AAA (incluidas)



SSH-30M2-2AAA



SENSOR DE HUMO	BATERÍA	INTER. /MASTER	VENTA MIN.
SSH-30M2-2AAA	Batería Alkalina 2x AAA	Niveles de sonido 85dB / 3ML	10u. / 50u.



SSPV-2AAA



x2 Baterías Alkalinas
(incluidas)



SSPV-BL



Interfaz Micro
USB 25V

Base desmontable
Acceso ON/OFF - Reset



SENSORES DE PUERTAS Y VENTANAS	ALIMENTACIÓN	CONEXIÓN	MATERIAL	INTER. /MASTER	VENTA MIN.
SSPV-2AAA	Alkalina 2x AAA	Inalámbrica 2.4 GHz	ABS	10u. / 20u.	10u.
SSPV-BL	Litio 3.7V/500mAh Recargable	Inalámbrica 2.4 GHz	PC	10u. / 20u.	10u.



Conexión USB 5V 1A



CSIR



CONTROL INFRA ROJO UNIVERSAL	ALIMENTACIÓN	MATERIAL	INTER. /MASTER	VENTA MIN.
CSIR	DC5V/1A / Línea USB-Typec (no incluye fuente)	PC+ABS	10u. / 100u	1u.



FC01-6A-15LUX



FC02-10A-80LUX



FC03-25A-80LUX



FC04-10A-35LUX

FOTOCÉLULAS	TENSIÓN	CORRIENTE	DETECCIÓN LUZ	MASTER	VENTA MIN.
FC01-6A-15LUX	AC220-240V	6A	<5-15LUX	Si	100u.
FC02-10A-80LUX	AC220-240V	10A	<5-80LUX	Si	100u.
FC03-25A-80LUX	AC220-240V	25A	<5-80LUX	Si	100u.
FC04-10A-35LUX	AC220-240V	10A	<5-35LUX	Si	50u.



SMEB-360-6M-IP20



SMEB-360-12M-IP20



SMPL-360-6M-E27

Potencia Máxima admisible (60W - E27)

SENSORES DE EMBUTIR Y ROSCA	TENSIÓN	ÁNGULO	DISTANCIA MÁX	MASTER	VENTA MIN.
SMEB-360-6M-IP20	AC220-240V	360°	6m	50u.	10u.
SMEB-360-12M-IP20	AC220-240V	360°	12m	50u.	10u.
SMPL-360-6M-E27	AC220-240V	360°	6m	50u.	10u.



SMTB-360-6M-IP20



SMTB-360-8M-IP20



SMTB-360-20M-IP20

MOVIMIENTO DE PARED/TECHO	TENSIÓN	ÁNGULO	DISTANCIA MÁX	UV	MASTER	VENTA MIN.
SMTB-360-6M-IP20	AC220-240V	360°	6m	Si	50u.	10u.
SMTB-360-8M-IP20	AC220-240V	360°	8m	Si	50u.	10u.
SMTB-360-20M-IP20	AC220-240V	360°	20m	Si	50u.	10u.



SMPB-180-12M-IP44
SMPN-180-12M-IP44

PARED



SMPB-180-12M-IP65
SMPN-180-12M-IP65

PARED Y TECHO

MOVIMIENTO DE PARED/TECHO	TENSIÓN	ÁNGULO	DISTANCIA MAX.	UV	MASTER	VENTA MIN.
SMPB-180-12M-IP44	AC220-240V	180°	12m	Si	50u.	10u.
SMPN-180-12M-IP44	AC220-240V	180°	12m	Si	50u.	10u.
SMPB-180-12M-IP65	AC220-240V	180°	12m	Si	50u.	10u.
SMPN-180-12M-IP65	AC220-240V	180°	12m	Si	50u.	10u.





Febo



Júpiter

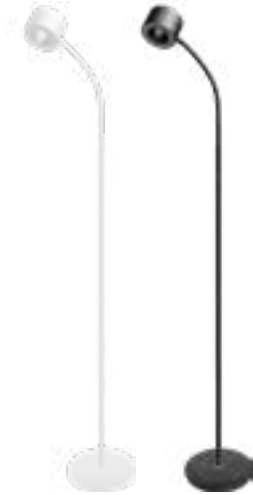

Marte



DE PIE	DIMERIZABLE	TIPO DE LUZ			POTENCIA	MASTER	VENTA MIN.
FEBO	No	Con portalámparas E27			20W máx	5u.	1u.
JÚPITER NEGRO	Si	2700K	4500K	6000K	10W	3u.	1u.
JÚPITER BLANCO	Si	2700K	4500K	6000K	10W	3u.	1u.
MARTE NEGRO	Si	2700K	4500K	6000K	11W	4u.	1u.
MARTE BLANCO	Si	2700K	4500K	6000K	11W	4u.	1u.



Mercurio



Baco



Vulcano



DE MESA	DIMERIZABLE	TIPO DE LUZ		CARGA	POTENCIA	MASTER	VENTA MIN.
MERCURIO	Si	Cálida	2700K	Inalámbrica 10W	5W	24u.	1u.
BACO	Si	Cálida	2700K	Inalámbrica 10W	5W	20u.	1u.
VULCANO	Si	Cálida	2700K	Inalámbrica 10W	5W	20u.	1u.



PLUTÓN

- Carga rápida inalámbrica 10W
- Salida USB
- Panel táctil
- Función dimerizable
- Brazo y base móvil
- Temperatura luminica regulable



SATURNO

- Carga rápida inalámbrica 10W
- Brazo flexible
- Panel táctil
- Función dimerizable



VENUS

- Carga rápida inalámbrica 10W
- Brazo y base móvil
- Panel táctil
- Función dimerizable

VELADORES		TIPO DE LUZ			CARGA	POTENCIA	MASTER	VENTA MIN.
PLUTÓN NEGRO	Si	2700K	4500K	6500K	Inalámbrica 5W	5W	6u.	1u.
PLUTÓN BLANCO	Si	2700K	4500K	6500K	Inalámbrica 5W	5W	6u.	1u.
SATURNO NEGRO	Si	2700K			Inalámbrica 5W	4W	6u.	1u.
SATURNO BLANCO	Si	2700K			Inalámbrica 5W	4W	6u.	1u.
VENUS NEGRO	Si	2700K			Inalámbrica 5W	8W	10u.	1u.
VENUS BLANCO	Si	2700K			Inalámbrica 5W	8W	10u.	1u.



CUPIDO

DIANA

JUNO



Salida USB



Panel táctil



Función dimerizable



Carga rápida inalámbrica 10W



Brazo flexible



Panel táctil



Función dimerizable



Carga rápida inalámbrica 10W



Brazo y base móvil



Panel táctil



Función dimerizable

VELADORES	DIMERIZABLE	TIPO DE LUZ			CARGA	POTENCIA	MASTER	VENTA MIN.
CUPIDO NEGRO	Si	2700K	4500K	6500K	Inalámbrica 10W	18W	4u.	1u.
CUPIDO BLANCO	Si	2700K	4500K	6500K	Inalámbrica 10W	18W	4u.	1u.
DIANA NEGRO	Si	2700K	4500K	6500K	USB	7W	8u.	1u.
DIANA BLANCO	Si	2700K	4500K	6500K	USB	7W	8u.	1u.
JUNO NEGRO	Si	2700K			Inalámbrica 5W	6W	6u.	1u.
JUNO BLANCO	Si	2700K			Inalámbrica 5W	6W	6u.	1u.



- Función dimerizable
- Temperatura luminica regulable
- Brazo y base movibles
- Panel táctil
- Carga rápida inalámbrica 10W



CERES

- Función dimerizable
- Autonomía de 2-3hs
- Batería de litio 1200mAh
- Panel táctil



MINERVA



- Función dimerizable
- Temperatura luminica regulable
- Brazo y base movibles
- Salida USB 5V/1A



NEPTUNO

- Función dimerizable
- Temperatura luminica regulable
- Brazo y base movibles
- Panel táctil



VESTA

VELADORES	DIMERIZABLE	TIPO DE LUZ			CARGA	POTECIA	MASTER	VENTA MIN.
CERES	Si	2700K	4500K	6500K	Inalambrica 10W	10W	12u.	1u.
MINERVA	Si	2700K			-	4W	6u.	1u.
NEPTUNO	Si	2700K	4500K	6500K	USB	7W	6u.	1u.
VESTA	Si	2700K	4500K	6500K	-	6W	6u.	1u.

MATERIAL DEL TUBO

NANO



TUBO LED NANO 9W T8 / 28x600mm					VIDA ÚTIL	
TNL-T8060WW	Cálido	3000°K	700lm	77 lm/W	30000hs	25u.
TNL-T8060NW	Neutro	4500°K	750lm	83 lm/W	30000hs	25u.
TNL-T8060CW	Frío	6000°K	800lm	88 lm/W	30000hs	25u.
TUBO LED NANO 18W T8 / 28x1195mm					VIDA ÚTIL	MASTER
TNL-T8120WW	Cálido	3000°K	1550lm	86 lm/W	30000hs	25u.
TNL-T8120NW	Neutro	4500°K	1600lm	88 lm/W	30000hs	25u.
TNL-T8120CW	Frío	6000°K	1650lm	91 lm/W	30000hs	25u.

MATERIAL DEL TUBO

VIDRIO



TUBO DE VIDRIO PRO



TUBO LED VIDRIO 9W T8 / 28x600mm					VIDA ÚTIL	MASTER
TL-T8060WW	Cálido	3000°K	700lm	77 lm/W	25.000hs	25u.
TL-T8060NW	Neutro	4500°K	750lm	83 lm/W	25.000hs	25u.
TL-T8060CW	Frío	6000°K	800lm	88 lm/W	25.000hs	25u.
TUBO LED VIDRIO 12W T8 / 28x900mm					VIDA ÚTIL	MASTER
TL-T8090-12WW	Cálido	3000°K	1080lm	90 lm/W	25.000hs	25u.
TL-T8090-12NW	Neutro	4500°K	1080lm	90 lm/W	25.000hs	25u.
TL-T8090-12CW	Frío	6000°K	1080lm	90 lm/W	25.000hs	25u.
TUBO LED VIDRIO 18W T8 / 28x1195mm					VIDA ÚTIL	MASTER
TL-T8120WW	Cálido	3000°K	1550lm	86 lm/W	25.000hs	25u.
TL-T8120NW	Neutro	4500°K	1600lm	88 lm/W	25.000hs	25u.
TL-T8120CW	Frío	6000°K	1650lm	91 lm/W	25.000hs	25u.
TUBO LED VIDRIO 25W T8 / 28x1500mm					VIDA ÚTIL	MASTER
TL-T8150-25WW	Cálido	3000°K	2250lm	90 lm/W	25.000hs	25u.
TL-T8150-25NW	Neutro	4500°K	2250lm	90 lm/W	25.000hs	25u.
TL-T8150-25CW	Frío	6000°K	2250lm	90 lm/W	25.000hs	25u.
TUBO LED VIDRIO PRO 18W T8 / 28x1200mm					VIDA ÚTIL	MASTER
TLP-T8120CW	Frío	6000°K	2160lm	120 lm/W	25.000hs	25u.

MATERIAL DEL TUBO

PVC+ALU



TUBO LED PVC+ALUMINIO 48W T8 / 25x2400mm					VIDA ÚTIL	MASTER
TPL-T8240-48-WW	Cálido	3000°K	3800lm	80 lm/W	25.000hs	20u.
TPL-T8240-48-NW	Neutro	4500°K	3800lm	80 lm/W	25.000hs	20u.
TPL-T8240-48CW	Frío	6000°K	3800lm	80 lm/W	25.000hs	20u.



Factor de Potencia 0.95

Eficiencia Lumínica de 120lm/W

Multitensión 100-240V



LUMINARIA LED ESTANCO 50W / 1200x78x66mm					PROTECCIÓN	MASTER
LEL-50-NW	Neutro	4500°K	6000lm	120 lm.xW	IP65	12u.
LEL-50-CW	Frío	6500°K	6000lm	120 lm.xW	IP65	12u.

PORTATUBO
SIMPLE



PORTATUBO
DOBLE



LISTÓN TUBO SIMPLE	TAMAÑO	CONECTOR	MATERIAL	MASTER
LT-060	60mm	G13	Aluminio	50u.
LT-090	90mm	G13	Aluminio	50u.
LT-120	120mm	G13	Aluminio	50u.
LT-150	150mm	G13	Aluminio	25u.
LT-240	240mm	G13	Aluminio	20u.

LISTÓN TUBO DOBLE	TAMAÑO	CONECTOR	MATERIAL	MASTER
LTD-120	120cm	G13	Aluminio	50u.



PORTATUBO
SIMPLE



PORTATUBO
DOBLE



ARTEFACTO ESTANCO 60CM				CONECTOR	PROTECCIÓN	MASTER
LET-1-60	Simple	Pot. Máx. 18W	670x66x62mm	G13	IP65	16u.
LET-2-60	Doble	Pot. Máx. 36W	670x100x62mm	G13	IP65	12u.
ARTEFACTO ESTANCO 120CM				CONECTOR	PROTECCIÓN	MASTER
LET-1-120	Simple	Pot. Máx. 18W	1270x66x62mm	G13	IP65	16u.
LET-2-120	Doble	Pot. Máx. 36W	1270x100x62mm	G13	IP65	12u.

PORTATUBO
PREMIUM
SIMPLE



PORTATUBO
PREMIUM
DOBLE



MÁS ILUMINACIÓN
Reflectante Premium



VISOR CRITAL
Acrílico Cristal Premium



BORNERA A PRESIÓN
De fácil instalación

ARTEFACTO ESTANCO PREMIUM				CONECTOR	PROTECCIÓN	MASTER
LETP2-1-120/1	Simple	Pot. Máx. 18W	1265x89x92mm	G13	IP65	16u.
LETP2-2-120/1	Doble	Pot. Máx. 36W	1265x130x92mm	G13	IP65	12u.

TS-P4B-CP/TS-P4N-CP



MODO ALTO

6Hs / 100lm	8Hs / 50lm
5Hs / 200lm	9Hs / 100lm
4Hs / 350lm	6Hs / 150lm



LUCES DE EMERGENCIA			POTENCIA	BATERÍA	MASTER
EML-30	Blanco Frío	6500°K	1.6W Máx.	Litio x1 3.7V 1.8aH	20u.
EML-60	Blanco Frío	6500°K	3.2W Máx.	Litio x2 3.7V 1.8aH	10u.
EML-90	Blanco Frío	6500°K	5.3W Máx.	Litio x2 3.7V 2.2aH	10u.



BATERIA DE LITIO 65x18mm	TENSIÓN	CORRIENTE	INTER / MASTER
BL-3.7-1.8	3.7V	1800mA	10u. / 400u.
BL-3.7-2.2	3.7V	2200mA	10u. / 400u.



LUZ DE EMERGENCIA COB DE EMBUTIR 140x100mm	POTENCIA	FLUJO LUMINOSO	MASTER	VENTA MIN.
EML-COB-300	3W	400lm	20u.	20u.



Gira 180°



Enchufe Incluido

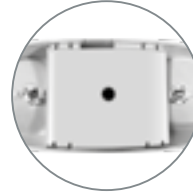

Orificios para Empotar



Batería de Litio Recargable



Autonomía 3hs



Tensión AC100-240V



Vida Útil 50.000 hs



Protección IP20

LUZ DE EMERGENCIA TIPO MANTIS 270x78x110mm			POTENCIA	FLUJO LUMINOSO	MASTER	VENTA MIN.
EML-MT-400-I	Blanco Frío	7000°K	2W	400lm	10u.	10u.



Botón de Testeo



MARCO PARA EMBUTIR

LUZ DE EMERGENCIA PARA APLICAR O EMBUTIR 65x18mm			POTENCIA	FLUJO LUMINOSO	MASTER	VENTA MIN.	
EML-IP65-400	Blanco Frío	6500°K	2.5W	400lm	20u.	20u.	44,04 USD
EML-IP65-MARCO-EMBUTIR	-	-	-	-	20u.	20u.	6,19 USD



LINTERNA PRO 70X40mm	POTENCIA	LUMEN	MODOS	AUTONOMIA	INTER / MASTER
LMFP-120-3AAA	3W	120lm	100% / 30% / Estroboscópica	5hs	12u. / 72u.



Mayor AUTONOMÍA
Con batería de litio de 3.7V 800mAh



PRODUCTO CERTIFICADO
IEC 60598-2-22
IEC 60598-1

ACCESORIOS INCLUIDOS



x2 tornillos
x2 tarugos

x2 accesorios
de suspensión

x2 accesorios
de fijación

1 Aplique superior

2 Aplique trasero

3 Aplique lateral

4 Aplique colgante



SEÑALES LUMINOSAS		POTENCIA	TENSIÓN	DIMENSIONES	MASTER
CSL-SALIDA		1W Máx.	220-240V	192X356mm	10u.
CSL-SAL-IZQ		1W Máx.	220-240V	192X356mm	10u.
CSL-SAL-DER		1W Máx.	220-240V	192X356mm	10u.
CSL-EMERGENCIA		1W Máx.	220-240V	192X356mm	10u.
CSL-EME-IZQ		1W Máx.	220-240V	192X356mm	10u.
CSL-EME-DER		1W Máx.	220-240V	192X356mm	10u.
CSL-PUERTA		1W Máx.	220-240V	192X356mm	10u.
CSL-ESCALERA		1W Máx.	220-240V	192X356mm	10u.
CSL-BANOS		1W Máx.	220-240V	192X356mm	10u.



	40W	PRO 48W
Tamaño 30120	295x1195mm	305x1205mm
Tamaño 6060	595x595mm	605x605mm
Lúmenes x W	90lm x W	100lm x W
LM80	No	SI
EMC	No	SI
Material Lente	PS	PMMA
UGR	No	SI
Vida Útil	25.000	50.000
Protección	IP20	IP40
Factor Potencia	0,98	0,98
Garantía	2 Años	5 Años



PANEL 40W				DIMENSIONES	MASTER
P40-595-PS-3600LM-WW	Cálido	3000°K	3600lm	595x595mm	10u.
P40-595-PS-3600LM-NW	Neutro	4500°K	3600lm		10u.
P40-595-PS-3600LM-CW	Frío	6000°K	3600lm		10u.
P40-1195-PS-3600LM-WW	Cálido	3000°K	3600lm	295x1195mm	10u.
P40-1195-PS-3600LM-NW	Neutro	4500°K	3600lm		10u.
P40-1195-PS-3600LM-CW	Frío	6000°K	3600lm		10u.



PANEL PRO 48W				DIMENSIONES	VENTA MIN.
P48-605-PMMA-4800LM-WW	Cálido	3000°K	4800lm	605x605mm	5u.
P48-605-PMMA-4800LM-NW	Neutro	4500°K	4800lm		5u.
P48-605-PMMA-4800LM-CW	Frío	6000°K	4800lm		5u.
P48-1205-PMMA-4800LM-WW	Cálido	3000°K	4800lm	305x1205mm	5u.
P48-1205-PMMA-4800LM-NW	Neutro	4500°K	4800lm		5u.
P48-1205-PMMA-4800LM-CW	Frío	6000°K	4800lm		5u.



DRIVER				MASTER	VENTA MIN.
P40-595-PS-3600LM-DR	Panel 60x60	AC 110-260V, 03A	DC 50-70V 40W	100u.	1u.
P40-1195-PS-3600LM-DR	Panel 30x120	AC 110-260V, 03A	DC 50-70V 40W	100u.	1u.
P48-605-PMMA-4800LM-DR	Panel 60x60	AC 110-260V, 02A	DC 60-80V 48W	100u.	1u.
P48-1205-PMMA-4800LM-DR	Panel 30x120	AC 110-260V, 02A	DC 60-80V 48W	100u.	1u.





ACCESORIOS PANELES		PANEL COMPATIBLE	PANEL ARMADO	INTER.	VENTA MIN.
PPLP6060	Plafón	595x595mm (40W)	600x600mm (40W)	-	20u.
PPLP30120	Plafón	295x1195mm (40W)	300x1200mm (40W)	-	20u.
PPLPL6060	Plafón PRO	605x605mm (48W)	610x610mm (48W)	-	20u.
PPLPL30120	Plafón PRO	305x1205mm (48W)	310x1210mm (48W)	-	20u.



ACCESORIOS PANELES		PANEL COMPATIBLE	PANEL ARMADO	INTER.	VENTA MIN.
AS-PANEL	Suspensión	Todos	-	20u.	100u.
AE-PANEL	Embutido	Todos	-	20u.	100u.
AF-PANEL	Fijación	Todos	-	20u.	100u.



PANEL COB 30W / 230x50mm					VIDA ÚTIL	VENTA MIN.
RTB30-WW	Cálido	3000°K	2500lm	83 lm/W	30000hs	10u.
RTB30-NW	Neutro	4500°K	2700lm	90 lm/W	30000hs	10u.
RTB30-CW	Frío	6000°K	2800lm	93 lm/W	30000hs	10u.



DRIVER PARA PANEL COB 30W			MASTER	VENTA MIN.
RTB30DR	AC100-265V 50-60Hz	DC28-38V 0.18A 30W Máx	100u.	20u.



PANEL COB DICRO MOVIL REDONDO 3W / 75x45mm					VIDA ÚTIL	MASTER
RTB3-WW	Cálido	3000°K	240lm	80 lm/W	25.000hs	50u.
RTB3-CW	Frío	6000°K	260lm	86 lm/W	25.000hs	50u.



PANEL COB DICRO MOVIL REDONDO 7W / 91,5x38mm					VIDA ÚTIL	MASTER
RTB7-WW	Cálido	3000°K	560lm	80 lm/W	25.000hs	50u.
RTB7-CW	Frío	6000°K	595lm	86 lm/W	25.000hs	50u.



PANEL COB DICRO MOVIL CUADRADO 3W / 75x45mm					VIDA ÚTIL	MASTER
STB3-WW	Cálido	3000°K	240lm	80 lm/W	25.000hs	50u.
STB3-CW	Frío	6000°K	260lm	86 lm/W	25.000hs	50u.



PANEL COB DICRO MOVIL CUADRADO 7W / 91,5x38mm					VIDA ÚTIL	MASTER
STB7-WW	Cálido	3000°K	560lm	80 lm/W	25.000hs	50u.
STB7-CW	Frío	6000°K	595lm	86 lm/W	25.000hs	50u.



PANEL EMBUTIR REDONDO					MEDIDAS	MASTER
PER06WW	6W	Cálido	3000°K	540lm	Ø118x18mm	40u.
PER06NW	6W	Neutro	4500°K	540lm	Ø118x18mm	40u.
PER06CW	6W	Frío	6000°K	540lm	Ø118x18mm	40u.
PER12WW	12W	Cálido	3000°K	1080lm	Ø167x18mm	30u.
PER12NW	12W	Neutro	4500°K	1080lm	Ø167x18mm	30u.
PER12CW	12W	Frío	6000°K	1080lm	Ø167x18mm	30u.
PER18WW	18W	Cálido	3000°K	1620lm	Ø221x18mm	30u.
PER18NW	18W	Neutro	4500°K	1620lm	Ø221x18mm	30u.
PER18CW	18W	Frío	6000°K	1620lm	Ø221x18mm	30u.
PER24WW	24W	Cálido	3000°K	2160lm	Ø296x18mm	10u.
PER24NW	24W	Neutro	4500°K	2160lm	Ø296x18mm	10u.
PER24CW	24W	Frío	6000°K	2160lm	Ø296x18mm	10u.

PANEL EMBUTIR CUADRADO					MEDIDAS	MASTER
PEC06WW	6W	Cálido	3000°K	540lm	116x116x18mm	40u.
PEC06NW	6W	Neutro	4500°K	540lm	116x116x18mm	40u.
PEC06CW	6W	Frío	6000°K	540lm	116x116x18mm	40u.
PEC12WW	12W	Cálido	3000°K	1080lm	167x167x18mm	30u.
PEC12NW	12W	Neutro	4500°K	1080lm	167x167x18mm	30u.
PEC12CW	12W	Frío	6000°K	1080lm	167x167x18mm	30u.
PEC18WW	18W	Cálido	3000°K	1620lm	219x219x18mm	30u.
PEC18NW	18W	Neutro	4500°K	1620lm	219x219x18mm	30u.
PEC18CW	18W	Frío	6000°K	1620lm	219x219x18mm	30u.
PEC24WW	24W	Cálido	3000°K	2160lm	292x292x18mm	10u.
PEC24NW	24W	Neutro	4500°K	2160lm	292x292x18mm	10u.
PEC24CW	24W	Frío	6000°K	2160lm	292x292x18mm	10u.



DRIVER PARA PANELES 6W / 12W / 18W / 24W				MASTER	VENTA MIN.
PEC06DR	6W	AC85-265V,50-60Hz	DC12-24V, 240-260mA, 6W Máx.	100u.	20u.
PEC12DR	12W	AC85-265V,50-60Hz	DC24-50V, 250-270mA, 12W Máx.	100u.	20u.
PEC18DR	18W	AC85-265V,50-60Hz	DC36-63V, 270-290mA, 18W Máx.	100u.	20u.
PEC24DR	24W	AC85-265V,50-60Hz	DC54-84V, 270-290mA, 24W Máx.	100u.	20u.



DRIVER DE EMERGENCIA PARA PANELES 6W / 12W / 18W / 24W			MASTER	VENTA MIN.
PEC6-24DRB	AC85-265V, 50-60Hz	DC57-68V, 270-290mA	100u.	10u.



PANEL PLAFÓN REDONDO					MEDIDAS	MASTER
PR06WW	6W	Cálido	3000°K	540lm	Ø116x32mm	40u.
PR06NW	6W	Neutro	4500°K	540lm	Ø116x32mm	40u.
PR06CW	6W	Frío	6000°K	540lm	Ø116x32mm	40u.
PR12WW	12W	Cálido	3000°K	1080lm	Ø165x32mm	30u.
PR12NW	12W	Neutro	4500°K	1080lm	Ø165x32mm	30u.
PR12CW	12W	Frío	6000°K	1080lm	Ø165x32mm	30u.
PR18WW	18W	Cálido	3000°K	1620lm	Ø219x32mm	30u.
PR18NW	18W	Neutro	4500°K	1620lm	Ø219x32mm	30u.
PR18CW	18W	Frío	6000°K	1620lm	Ø219x32mm	30u.
PR24WW	24W	Cálido	3000°K	2160lm	Ø295x32mm	10u.
PR24NW	24W	Neutro	4500°K	2160lm	Ø295x32mm	10u.
PR24CW	24W	Frío	6000°K	2160lm	Ø295x32mm	10u.

PANEL PLAFÓN CUADRADO					MEDIDAS	MASTER
PC06WW	6W	Cálido	3000°K	540lm	116x116x32mm	40u.
PC06NW	6W	Neutro	4500°K	540lm	116x116x32mm	40u.
PC06CW	6W	Frío	6000°K	540lm	116x116x32mm	40u.
PC12WW	12W	Cálido	3000°K	1080lm	165x165x32mm	30u.
PC12NW	12W	Neutro	4500°K	1080lm	165x165x32mm	30u.
PC12CW	12W	Frío	6000°K	1080lm	165x165x32mm	30u.
PC18WW	18W	Cálido	3000°K	1620lm	219x219x32mm	30u.
PC18NW	18W	Neutro	4500°K	1620lm	219x219x32mm	30u.
PC18CW	18W	Frío	6000°K	1620lm	219x219x32mm	30u.
PC24WW	24W	Cálido	3000°K	2160lm	295x295x32mm	10u.
PC24NW	24W	Neutro	4500°K	2160lm	295x295x32mm	10u.
PC24CW	24W	Frío	6000°K	2160lm	295x295x32mm	10u.



DRIVER PARA PANELES 6W / 12W / 18W / 24W				MASTER	VENTA MIN.
PEC06DR	6W	AC85-265V,50-60Hz	DC12-24V, 240-260mA, 6W Máx.	100u.	20u.
PEC12DR	12W	AC85-265V,50-60Hz	DC24-50V, 250-270mA, 12W Máx.	100u.	20u.
PEC18DR	18W	AC85-265V,50-60Hz	DC36-63V, 270-290mA, 18W Máx.	100u.	20u.
PEC24DR	24W	AC85-265V,50-60Hz	DC54-84V, 270-290mA, 24W Máx.	100u.	20u.



DRIVER DE EMERGENCIA PARA PANELES 6W / 12W / 18W / 24W			MASTER	VENTA MIN.
PEC6-24DRB	AC85-265V, 50-60Hz	DC57-68V, 270-290mA	100u.	10u.



PANEL EMBUTIR REDONDO					MEDIDAS	MASTER
NPER18WW	18W	Cálido	3000°K	1600lm	Ø221x18mm	40u.
NPER18NW	18W	Neutro	4500°K	1610lm	Ø221x18mm	40u.
NPER18CW	18W	Frío	6000°K	1620lm	Ø221x18mm	40u.
NPER24WW	24W	Cálido	3000°K	2140lm	Ø296x18mm	30u.
NPER24NW	24W	Neutro	4500°K	2150lm	Ø296x18mm	30u.
NPER24CW	24W	Frío	6000°K	2160lm	Ø296x18mm	30u.

PANEL EMBUTIR CUADRADO					MEDIDAS	MASTER
NPEC18WW	18W	Cálido	3000°K	1600lm	219x219x18mm	40u.
NPEC18NW	18W	Neutro	4500°K	1610lm	219x219x18mm	40u.
NPEC18CW	18W	Frío	6000°K	1620lm	219x219x18mm	40u.
NPEC24WW	24W	Cálido	3000°K	2140lm	292x219x18mm	30u.
NPEC24NW	24W	Neutro	4500°K	2150lm	292x219x18mm	30u.
NPEC24CW	24W	Frío	6000°K	2160lm	292x219x18mm	30u.



DRIVER PARA PANELES 6W / 12W / 18W / 24W				MASTER	VENTA MIN.
PEC06DR	6W	AC85-265V,50-60Hz	DC12-24V, 240-260mA, 6W Máx.	100u.	20u.
PEC12DR	12W	AC85-265V,50-60Hz	DC24-50V, 250-270mA, 12W Máx.	100u.	20u.
PEC18DR	18W	AC85-265V,50-60Hz	DC36-63V, 270-290mA, 18W Máx.	100u.	20u.
PEC24DR	24W	AC85-265V,50-60Hz	DC54-84V, 270-290mA, 24W Máx.	100u.	20u.



DRIVER DE EMERGENCIA PARA PANELES 6W / 12W / 18W / 24W			MASTER	VENTA MIN.	
PEC6-24DRB	AC85-265V, 50-60Hz		DC57-68V, 270-290mA	100u.	10u.



PANEL PLAFÓN REDONDO BLACK SERIES					MEDIDAS	MASTER
NPR06WW	6W	Cálido	3000°K	510lm	Ø116x32mm	40u.
NPR06CW	6W	Frío	6000°K	540lm	Ø116x32mm	40u.
NPR12WW	12W	Cálido	3000°K	1020lm	Ø165x32mm	30u.
NPR12CW	12W	Frío	6000°K	1080lm	Ø165x32mm	30u.
NPR18WW	18W	Cálido	3000°K	1600lm	Ø219x32mm	30u.
NPR18NW	18W	Neutro	4500°K	1610lm	Ø219x32mm	30u.
NPR18CW	18W	Frío	6000°K	1620lm	Ø219x32mm	30u.
NPR24WW	24W	Cálido	3000°K	2040lm	Ø295x32mm	10u.
NPR24NW	24W	Neutro	4500°K	2150lm	Ø295x32mm	10u.
NPR24CW	24W	Frío	6000°K	2160lm	Ø295x32mm	10u.

PANEL PLAFÓN CUADRADO BLACK SERIES					MEDIDAS	MASTER
NPC06WW	6W	Cálido	3000°K	510lm	116x116x32mm	40u.
NPC06CW	6W	Frío	6000°K	540lm	116x116x32mm	40u.
NPC12WW	12W	Cálido	3000°K	1020lm	165x116x32mm	30u.
NPC12CW	12W	Frío	6000°K	1080lm	165x116x32mm	30u.
NPC18WW	18W	Cálido	3000°K	1600lm	219x219x32mm	30u.
NPC18NW	18W	Neutro	4500°K	1610lm	219x219x32mm	30u.
NPC18CW	18W	Frío	6000°K	1620lm	219x219x32mm	30u.
NPC24WW	24W	Cálido	3000°K	2040lm	295x295x32mm	10u.
NPC24NW	24W	Neutro	4500°K	2150lm	295x295x32mm	10u.
NPC24CW	24W	Frío	6000°K	2160lm	295x295x32mm	10u.



DRIVER PARA PANELES 6W / 12W / 18W / 24W				MASTER	VENTA MIN.
PEC06DR	6W	AC85-265V,50-60Hz	DC12-24V, 240-260mA, 6W Máx.	100u.	20u.
PEC12DR	12W	AC85-265V,50-60Hz	DC24-50V, 250-270mA, 12W Máx.	100u.	20u.
PEC18DR	18W	AC85-265V,50-60Hz	DC36-63V, 270-290mA, 18W Máx.	100u.	20u.
PEC24DR	24W	AC85-265V,50-60Hz	DC54-84V, 270-290mA, 24W Máx.	100u.	20u.



DRIVER DE EMERGENCIA PARA PANELES 6W / 12W / 18W / 24W			MASTER	VENTA MIN.
PEC6-24DRB	AC85-265V, 50-60Hz	DC57-68V, 270-290mA	100u.	10u.



PANEL PLAFÓN REDONDO PLATIL SERIES					MEDIDAS	MASTER
PPR06WW	6W	Cálido	3000°K	510lm	Ø116x32mm	40u.
PPR06CW	6W	Frío	6000°K	540lm	Ø116x32mm	40u.
PPR12WW	12W	Cálido	3000°K	1020lm	Ø165x32mm	30u.
PPR12CW	12W	Frío	6000°K	1080lm	Ø165x32mm	30u.
PPR18WW	18W	Cálido	3000°K	1530lm	Ø219x32mm	30u.
PPR18CW	18W	Frío	6000°K	1620lm	Ø219x32mm	30u.
PPR24WW	24W	Cálido	3000°K	2040lm	Ø295x32mm	10u.
PPR24CW	24W	Frío	6000°K	2160lm	Ø295x32mm	10u.

PANEL PLAFÓN CUADRADO PLATIL SERIES					MEDIDAS	MASTER
PPC06WW	6W	Cálido	3000°K	510lm	116x116x32mm	40u.
PPC06CW	6W	Frío	6000°K	540lm	116x116x32mm	40u.
PPC12WW	12W	Cálido	3000°K	1020lm	165x165x32mm	30u.
PPC12CW	12W	Frío	6000°K	1080lm	165x165x32mm	30u.
PPC18WW	18W	Cálido	3000°K	1530lm	219x219x32mm	30u.
PPC18CW	18W	Frío	6000°K	1620lm	219x219x32mm	30u.
PPC24WW	24W	Cálido	3000°K	2040lm	295x295x32mm	10u.
PPC24CW	24W	Frío	6000°K	2160lm	295x295x32mm	10u.



DRIVER PARA PANELES 6W / 12W / 18W / 24W				MASTER	VENTA MIN.
PEC06DR	6W	AC85-265V,50-60Hz	DC12-24V, 240-260mA, 6W Máx.	100u.	20u.
PEC12DR	12W	AC85-265V,50-60Hz	DC24-50V, 250-270mA, 12W Máx.	100u.	20u.
PEC18DR	18W	AC85-265V,50-60Hz	DC36-63V, 270-290mA, 18W Máx.	100u.	20u.
PEC24DR	24W	AC85-265V,50-60Hz	DC54-84V, 270-290mA, 24W Máx.	100u.	20u.



DRIVER DE EMERGENCIA PARA PANELES 6W / 12W / 18W / 24W			MASTER	VENTA MIN.	
PEC6-24DRB	AC85-265V, 50-60Hz		DC57-68V, 270-290mA	100u.	10u.



DRIVER



BATERÍA



P4048-DE	48W	AC180-260V, 50-60Hz	65-72V, 580-620mA	24u.	24u.
----------	-----	---------------------	-------------------	------	------

CIRCUITO DE CONEXIONADO

> Fácil reemplazo de batería



> Detalle del DRIVER





0.95
Factor de potencia

Energía Eficiente

Fácil de instalar



Interconectables hasta 300W



Interruptor manual



T5 LISTÓN LED 5W / 460x26x35mm					MEDIDAS	MASTER	VENTA MIN.
T5-30-5W-WW	Cálido	3000°K	450lm	90 lm/W	460x26x35mm	100u.	10u.
T5-30-5W-CW	Frío	6500°K	450lm	90 lm/W	460x26x35mm	100u.	10u.

T5 LISTÓN LED 9W / 760x26x35mm					MEDIDAS	MASTER	VENTA MIN.
T5-60-9W-WW	Cálido	3000°K	810lm	90 lm/W	760x26x35mm	50u.	10u.
T5-60-9W-CW	Frío	6500°K	810lm	90 lm/W	760x26x35mm	50u.	10u.

T5 LISTÓN LED 13W / 1060x26x35mm					MEDIDAS	MASTER	VENTA MIN.
T5-90-13W-WW	Cálido	3000°K	1170lm	90 lm/W	1060x26x35mm	50u.	10u.
T5-90-13W-CW	Frío	6500°K	1170lm	90 lm/W	1060x26x35mm	50u.	10u.

T5 LISTÓN LED 18W / 1360x26x35mm					MEDIDAS	MASTER	VENTA MIN.
T5-120-18W-WW	Cálido	3000°K	1620lm	90 lm/W	1360x26x35mm	50u.	10u.
T5-120-18W-CW	Frío	6500°K	1620lm	90 lm/W	1360x26x35mm	50u.	10u.

SKYLINE MACROLED®



Escanee o haga click en el
código para ver el vídeo

Apliques



Difuso

Focal

Panal



Dimerizable
con fuente

ACCESORIO MÓVIL

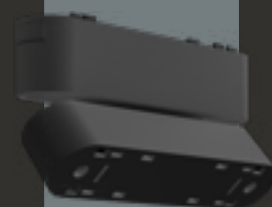

Adicioná un eje de rotación
de 90° a tus cabezales de
11 y 22cm

CABEZAL DIFUSO	ÁNGULO	TEMPCOLOR	LARGO	POTENCIA	LÚMENES	MASTER	VENTA MIN.
RMS-CD114-N-6W-WW	Difuso 90°	Blanco Cálido 2700K	11cm	6W	240lm	50u.	1u.
RMS-CD222-N-12W-WW			22cm	12W	500lm	50u.	1u.
RMS-CD330-N-16W-WW			33cm	16W	640lm	50u.	1u.

CABEZAL FOCAL	ÁNGULO	TEMPCOLOR	LARGO	POTENCIA	LÚMENES	MASTER	VENTA MIN.
RMS-CF114-N-6W-WW	Focal 36°	Blanco Cálido 2700K	11cm	6W	390lm	50u.	1u.
RMS-CF222-N-12W-WW			22cm	12W	880lm	50u.	1u.
RMS-CF330-N-16W-WW			33cm	16W	1040lm	50u.	1u.

CABEZAL PANAL	ÁNGULO	TEMPCOLOR	LARGO	POTENCIA	LÚMENES	MASTER	VENTA MIN.
RMS-CP114-N-6W-WW	Panal 60°	Blanco Cálido 2700K	11cm	6W	70lm	50u.	1u.
RMS-CP222-N-12W-WW			22cm	12W	160lm	50u.	1u.
RMS-CP330-N-16W-WW			33cm	16W	210lm	50u.	1u.

MÓDULOS MÓVILES PARA CABEZALES	DIMENSIONES	LÚMENES	MASTER	VENTA MIN.
RMS-MM-N-6W	11cm	6W	50u.	1u.
RMS-MM-N-12W	22cm	12W	50u.	1u.

Apliques

SMART

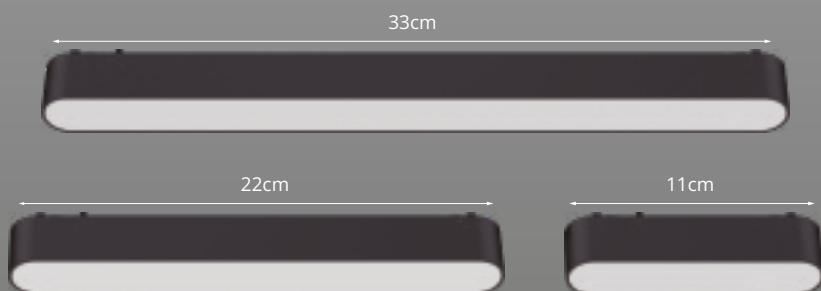

CABEZAL DIFUSO	ÁNGULO	TEMPCOLOR	LARGO	POTENCIA	LÚMENES	MASTER	VENTA MIN.
RMS-S-CD114-N-6W	Difuso 90°	2000K-5000K	11cm	6W	240lm	50u.	1u.
RMS-S-CD222-N-12W			22cm	12W	500lm	50u.	1u.
RMS-S-CD330-N-16W			33cm	16W	640lm	50u.	1u.

CABEZAL FOCAL	ÁNGULO	TEMPCOLOR	LARGO	POTENCIA	LÚMENES	MASTER	VENTA MIN.
RMS-S-CF114-N-6W	Focal 36°	2000K-5000K	11cm	6W	390lm	50u.	1u.
RMS-S-CF222-N-12W			22cm	12W	880lm	50u.	1u.
RMS-S-CF330-N-16W			33cm	16W	1040lm	50u.	1u.

CABEZAL PANEL	ÁNGULO	TEMPCOLOR	LARGO	POTENCIA	LÚMENES	MASTER	VENTA MIN.
RMS-S-CP114-N-6W	Panel 60°	2000K-5000K	11cm	6W	70lm	50u.	1u.
RMS-S-CP222-N-12W			22cm	12W	160lm	50u.	1u.
RMS-S-CP330-N-16W			33cm	16W	210lm	50u.	1u.

MÓDULOS MÓVILES PARA CABEZALES	DIMENSIONES	POTENCIA	MASTER	VENTA MIN.
RMS-MM-N-6W	11cm	6W	50u.	1u.
RMS-MM-N-12W	22cm	12W	50u.	1u.

Apliques



Difuso

Focal

Panal



Dimerizable
con fuente

ACCESORIO MÓVIL

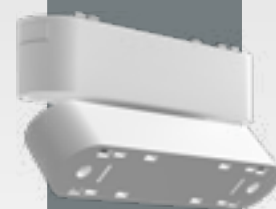

Adisioná un eje de rotación
de 90° a tus cabezales de
11 y 22cm

CABEZAL DIFUSO	ÁNGULO	TEMPCOLOR	LARGO	POTENCIA	LÚMENES	MASTER	VENTA MIN.
RMS-CD114-B-6W-WW	Difuso 90°	Blanco Cálido 2700K	11cm	6W	240lm	50u.	1u.
RMS-CD222-B-12W-WW			22cm	12W	500lm	50u.	1u.
RMS-CD330-B-16W-WW			33cm	16W	640lm	50u.	1u.

CABEZAL FOCAL	ÁNGULO	TEMPCOLOR	LARGO	POTENCIA	LÚMENES	MASTER	VENTA MIN.
RMS-CF114-B-6W-WW	Focal 36°	Blanco Cálido 2700K	11cm	6W	390lm	50u.	1u.
RMS-CF222-B-12W-WW			22cm	12W	880lm	50u.	1u.
RMS-CF330-B-16W-WW			33cm	16W	1040lm	50u.	1u.

CABEZAL PANAL	ÁNGULO	TEMPCOLOR	LARGO	POTENCIA	LÚMENES	MASTER	VENTA MIN.
RMS-CP114-B-6W-WW	Panal 60°	Blanco Cálido 2700K	11cm	6W	70lm	50u.	1u.
RMS-CP222-B-12W-WW			22cm	12W	160lm	50u.	1u.
RMS-CP330-B-16W-WW			33cm	16W	210lm	50u.	1u.

MÓDULOS MÓVILES PARA CABEZALES	LARGO	POTENCIA	MASTER	VENTA MIN.
RMS-MM-B-6W	11cm	6W	50u.	1u.
RMS-MM-B-12W	22cm	12W	50u.	1u.

Apliques

SMART

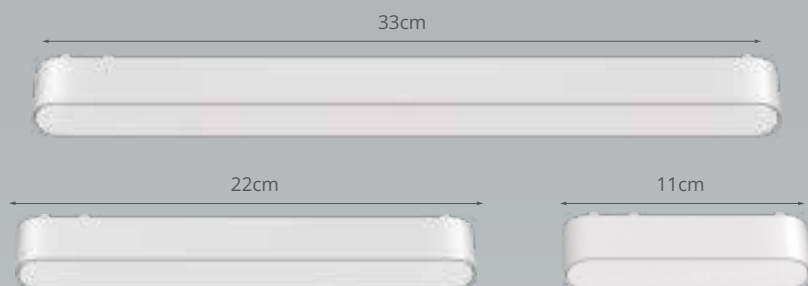

ACCESORIO MÓVIL



Adicioná un eje de rotación de 90° a tus cabezales de 11 y 22cm

Difuso

Focal

Panal



Dimerizable con App

2000K - 5000K

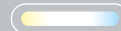

Cambio de Temperatura con App



DEPONIBLE EN Google Play

Consigúelo en el App Store

CABEZAL DIFUSO	ÁNGULO	TEMPCOLOR	LARGO	POTENCIA	LÚMENES	MASTER	VENTA MIN.
RMS-S-CD114-B-6W	Difuso 90°	2000K-5000K	11cm	6W	240lm	50u.	1u.
RMS-S-CD222-B-12W			22cm	12W	500lm	50u.	1u.
RMS-S-CD330-B-16W			33cm	16W	640lm	50u.	1u.

CABEZAL FOCAL	ÁNGULO	TEMPCOLOR	LARGO	POTENCIA	LÚMENES	MASTER	VENTA MIN.
RMS-S-CF114-B-6W	Focal 36°	2000K-5000K	11cm	6W	390lm	50u.	1u.
RMS-S-CF222-B-12W			22cm	12W	880lm	50u.	1u.
RMS-S-CF330-B-16W			33cm	16W	1040lm	50u.	1u.

CABEZAL PANAL	ÁNGULO	TEMPCOLOR	LARGO	POTENCIA	LÚMENES	MASTER	VENTA MIN.
RMS-S-CP114-B-6W	Panal 60°	2000K-5000K	11cm	6W	70lm	50u.	1u.
RMS-S-CP222-B-12W			22cm	12W	160lm	50u.	1u.
RMS-S-CP330-B-16W			33cm	16W	210lm	50u.	1u.

MÓDULOS MÓVILES PARA CABEZALES	LARGO	POTENCIA	MASTER	VENTA MIN.
RMS-MM-B-6W	11cm	6W	50u.	1u.
RMS-MM-B-12W	22cm	12W	50u.	1u.



SPOT MÓVIL			TEMPCOLOR	MODELO	ÁNGULO	MASTER	VENTA MIN.
Simple 5W	9cm	275lm	Blanco Cálido 2700K	RMS-CM-N-5W-15G-WW	15°	30u.	1u.
				RMS-CM-N-5W-24G-WW	24°	30u.	1u.
				RMS-CM-N-5W-36G-WW	36°	30u.	1u.
Doble 10W	9cm	700lm	Blanco Cálido 2700K	RMS-CMD-N-10W-15G-WW	15°	30u.	1u.
				RMS-CMD-N-10W-24G-WW	24°	30u.	1u.
				RMS-CMD-N-10W-36G-WW	36°	30u.	1u.
Simple 7W	14cm	370lm	Blanco Cálido 2700K	RMS-CM-N-7W-15G-WW	15°	30u.	1u.
				RMS-CM-N-7W-24G-WW	24°	30u.	1u.
				RMS-CM-N-7W-36G-WW	36°	30u.	1u.
Doble 14W	14cm	980lm	Blanco Cálido 2700K	RMS-CMD-N-14W-15G-WW	15°	30u.	1u.
				RMS-CMD-N-14W-24G-WW	24°	30u.	1u.
				RMS-CMD-N-14W-36G-WW	36°	30u.	1u.
Simple 12W	13cm	840lm	Blanco Cálido 2700K	RMS-CM-N-12W-15G-WW	15°	30u.	1u.
				RMS-CM-N-12W-24G-WW	24°	30u.	1u.
				RMS-CM-N-12W-36G-WW	36°	30u.	1u.
Simple 15W	17cm	1050lm	Blanco Cálido 2700K	RMS-CM-N-15W-15G-WW	15°	30u.	1u.
				RMS-CM-N-15W-24G-WW	24°	30u.	1u.
				RMS-CM-N-15W-36G-WW	36°	30u.	1u.

Spot Móvil

SMART

SKYLINE



SPOT MÓVIL	LARGO	LÚMENES	TEMPCOLOR	MODELO	ÁNGULO	MASTER	VENTA MIN.
Simple 5W	9cm	275lm	2000K-5000K	RMS-S-CM-N-5W-24G	24°	30u.	1u.

SPOT MÓVIL	LARGO	LÚMENES	TEMPCOLOR	MODELO	ÁNGULO	MASTER	VENTA MIN.
Doble 10W	9cm	700lm	2000K-5000K	RMS-S-CMD-N-10W-24G	24°	30u.	1u.

SPOT MÓVIL	LARGO	LÚMENES	TEMPCOLOR	MODELO	ÁNGULO	MASTER	VENTA MIN.
Simple 7W	14cm	370lm	2000K-5000K	RMS-S-CM-N-7W-24G	24°	30u.	1u.

SPOT MÓVIL	LARGO	LÚMENES	TEMPCOLOR	MODELO	ÁNGULO	MASTER	VENTA MIN.
Doble 14W	14cm	980lm	2000K-5000K	RMS-S-CMD-N-14W-24G	24°	30u.	1u.

SPOT MÓVIL	LARGO	LÚMENES	TEMPCOLOR	MODELO	ÁNGULO	MASTER	VENTA MIN.
Simple 12W	13cm	840lm	2000K-5000K	RMS-S-CM-N-12W-24G	24°	30u.	1u.

SPOT MÓVIL	LARGO	LÚMENES	TEMPCOLOR	MODELO	ÁNGULO	MASTER	VENTA MIN.
Simple 15W	17cm	1050lm	2000K-5000K	RMS-S-CM-N-15W-24G	24°	30u.	1u.

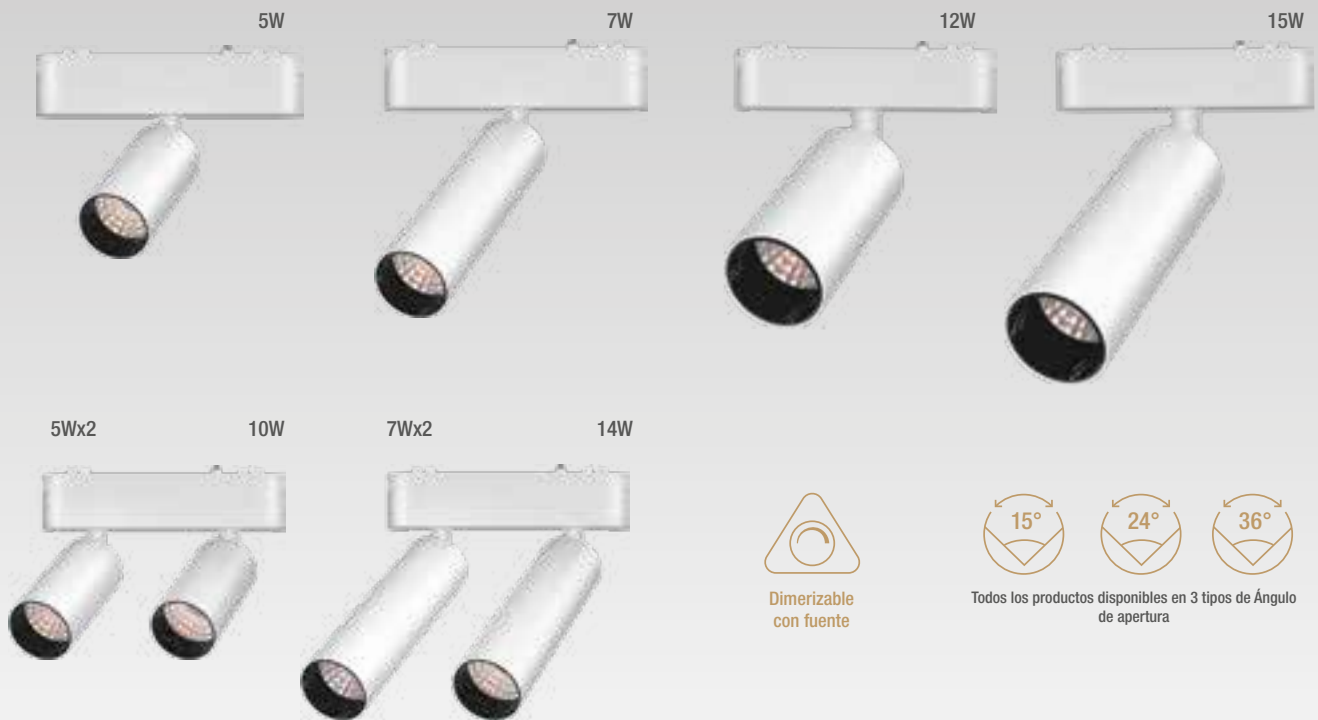

SPOT MÓVIL	LARGO	TEMPCOLOR	MODELO	ÁNGULO	MASTER	VENTA MIN.
Simple 5W	9cm	275lm	RMS-CM-B-5W-15G-WW	15°	30u.	1u.
			RMS-CM-B-5W-24G-WW	24°	30u.	1u.
			RMS-CM-B-5W-36G-WW	36°	30u.	1u.
Doble 10W	9cm	700lm	RMS-CMD-B-10W-15G-WW	15°	30u.	1u.
			RMS-CMD-B-10W-24G-WW	24°	30u.	1u.
			RMS-CMD-B-10W-36G-WW	36°	30u.	1u.
Simple 7W	14cm	370lm	RMS-CM-B-7W-15G-WW	15°	30u.	1u.
			RMS-CM-B-7W-24G-WW	24°	30u.	1u.
			RMS-CM-B-7W-36G-WW	36°	30u.	1u.
Doble 14W	14cm	980lm	RMS-CMD-B-14W-15G-WW	15°	30u.	1u.
			RMS-CMD-B-14W-24G-WW	24°	30u.	1u.
			RMS-CMD-B-14W-36G-WW	36°	30u.	1u.
Simple 12W	13cm	840lm	RMS-CM-B-12W-15G-WW	15°	30u.	1u.
			RMS-CM-B-12W-24G-WW	24°	30u.	1u.
			RMS-CM-B-12W-36G-WW	36°	30u.	1u.
Simple 15W	17cm	1050lm	RMS-CM-B-15W-15G-WW	15°	30u.	1u.
			RMS-CM-B-15W-24G-WW	24°	30u.	1u.
			RMS-CM-B-15W-36G-WW	36°	30u.	1u.

Spot Móvil

SMART

SKYLINE



SPOT MÓVIL	LARGO	LÚMENES	TEMPCOLOR	MODELO	ÁNGULO	MASTER	VENTA MIN.
Simple 5W	9cm	275lm	2000K-5000K	RMS-S-CM-B-5W-24G	24°	30u.	1u.
Doble 10W	9cm	700lm	2000K-5000K	RMS-S-CMD-B-10W-24G	24°	30u.	1u.
Simple 7W	14cm	370lm	2000K-5000K	RMS-S-CM-B-7W-24G	24°	30u.	1u.
Doble 14W	14cm	980lm	2000K-5000K	RMS-S-CMD-B-14W-24G	24°	30u.	1u.
Simple 12W	13cm	840lm	2000K-5000K	RMS-S-CM-B-12W-24G	24°	30u.	1u.
Simple 15W	17cm	1050lm	2000K-5000K	RMS-S-CM-B-15W-24G	24°	30u.	1u.

Colgante
TUBular

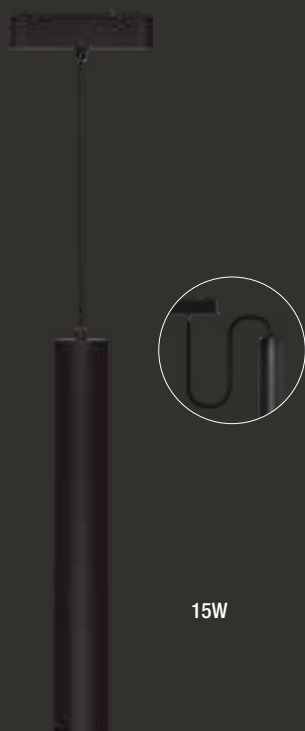

15W

Colgante Esférico
Difuso



10W

Colgante Esférico
Focal



12W

COLGANTE TUBULAR	TEMP.COLOR	LARGO	POTENCIA	LÚMENES	ÁNGULO	MASTER	VENTA MIN.
RMS-CC-N-9W-24G-WW	Blanco Cálido 2700K	100cm	9W	450lm	24°	20u.	1u.
RMS-CC-N-9W-36G-WW		100cm	9W	450lm	36°	20u.	1u.
RMS-CC-N-15W-15G-WW		100cm	15W	750lm	15°	30u.	1u.
RMS-CC-N-15W-24G-WW		100cm	15W	750lm	24°	30u.	1u.
RMS-CC-N-15W-36G-WW		100cm	15W	750lm	36°	30u.	1u.

COLGANTE ESFÉRICO DIFUSO	TEMP.COLOR	LARGO	POTENCIA	LÚMENES	ÁNGULO	MASTER	VENTA MIN.
RMS-CED-N-10W-WW	Cálido 2700K	100cm	10W	700lm	120°	20u.	1u.

APLIQUE ESFÉRICO DIFUSO	TEMP.COLOR	LARGO	POTENCIA	LÚMENES	ÁNGULO	MASTER	VENTA MIN.
RMS-AED-N-10W-WW	Cálido 2700K	11cm	10W	700lm	120°	20u.	1u.

COLGANTE ESFÉRICO FOCAL	TEMP.COLOR	LARGO	POTENCIA	LÚMENES	ÁNGULO	MASTER	VENTA MIN.
RMS-CEF-N-12W-WW	Cálido 2700K	100cm	12W	780lm	24°	20u.	1u.

APLIQUE ESFÉRICO FOCAL	TEMP.COLOR	LARGO	POTENCIA	LÚMENES	ÁNGULO	MASTER	VENTA MIN.
RMS-AEF-N-12W-24G-WW	Blanco Cálido 2700K	11cm	12W	780lm	24°	20u.	1u.
RMS-AEF-N-12W-36G-WW		11cm	12W	780lm	36°	20u.	1u.

Colgante TUBular

Colgante Esférico Difuso

Colgante Esférico Focal



15W



10W



12W



Dimerizable con App

2000K - 5000K



Cambio de Temperatura con App



DISPONIBLE EN Google Play

Consíguelo en el App Store



COLGANTE TUBULAR		TEMP.COLOR	LARGO	POTENCIA	LÚMENES	ÁNGULO	MASTER	VENTA MIN.
RMS-S-CC-N-15W-24G	ø45mm	2000K-5000K	100cm	15W	750lm	24°	30u.	1u.
RMS-S-CC-N-15W-36G	ø45mm	2000K-5000K	100cm	15W	750lm	36°	30u.	1u.

COLGANTE ESFÉRICO DIFUSO		TEMP.COLOR	LARGO	POTENCIA	LÚMENES	ÁNGULO	MASTER	VENTA MIN.
RMS-S-CED-N-10W	ø100mm	2000K-5000K	100cm	10W	700lm	120°	20u.	1u.

APLIQUE ESFÉRICO DIFUSO		TEMP.COLOR	LARGO	POTENCIA	LÚMENES	ÁNGULO	MASTER	VENTA MIN.
RMS-S-AED-N-10W	ø100mm	2000K-5000K	11cm	10W	700lm	120°	20u.	1u.

COLGANTE ESFÉRICO FOCAL		TEMP.COLOR	LARGO	POTENCIA	LÚMENES	ÁNGULO	MASTER	VENTA MIN.
RMS-S-CEF-N-12W	ø100mm	2000K-5000K	100cm	12W	780lm	24°	20u.	1u.

APLIQUE ESFÉRICO FOCAL		TEMP.COLOR	LARGO	POTENCIA	LÚMENES	ÁNGULO	MASTER	VENTA MIN.
RMS-S-AEF-N-12W-24G	ø100mm	2000K-5000K	11cm	12W	780lm	24°	20u.	1u.

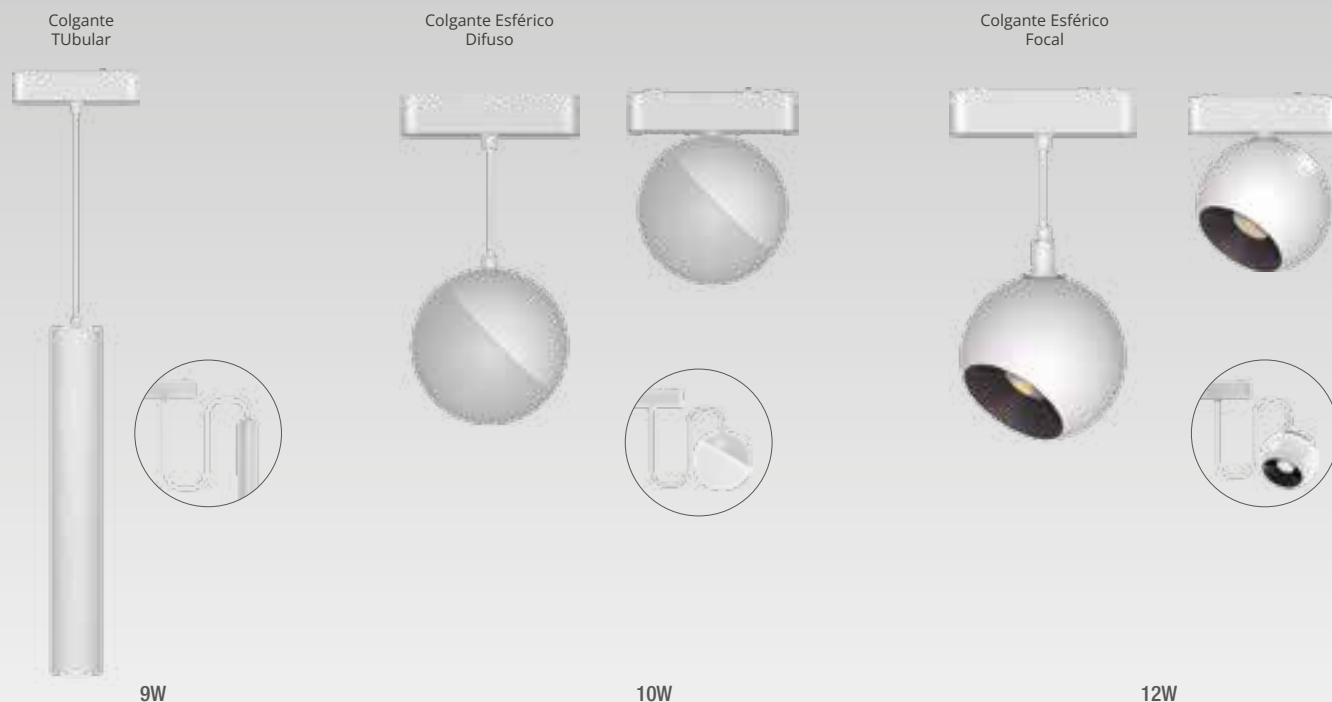

COLGANTE TUBULAR		TEMP.COLOR	LARGO	POTENCIA	LÚMENES	ÁNGULO	MASTER	VENTA MIN.
RMS-CC-B-9W-24G-WW	ø50mm	Blanco Cálido 2700K	100cm	9W	450lm	24°	20u.	1u.
RMS-CC-B-9W-36G-WW	ø50mm		100cm	9W	450lm	36°	20u.	1u.
RMS-CC-B-15W-15G-WW	ø45mm		100cm	15W	750lm	15°	30u.	1u.
RMS-CC-B-15W-24G-WW	ø45mm		100cm	15W	750lm	24°	30u.	1u.
RMS-CC-B-15W-36G-WW	ø45mm		100cm	15W	750lm	36°	30u.	1u.
COLGANTE ESFÉRICO DIFUSO		TEMP.COLOR	LARGO	POTENCIA	LÚMENES	ÁNGULO	MASTER	VENTA MIN.
RMS-CED-B-10W-WW	ø100mm	Cálido 2700K	100cm	10W	700lm	120°	20u.	1u.
APLIQUE ESFÉRICO DIFUSO		TEMP.COLOR	LARGO	POTENCIA	LÚMENES	ÁNGULO	MASTER	VENTA MIN.
RMS-AED-B-10W-WW	ø100mm	Cálido 2700K	11cm	10W	700lm	120°	20u.	1u.
APLIQUE ESFÉRICO FOCAL		TEMP.COLOR	LARGO	POTENCIA	LÚMENES	ÁNGULO	MASTER	VENTA MIN.
RMS-CEF-B-12W-WW	ø100mm	Cálido 2700K	100cm	12W	780lm	24°	20u.	1u.
APLIQUE ESFÉRICO FOCAL		TEMP.COLOR	LARGO	POTENCIA	LÚMENES	ÁNGULO	MASTER	VENTA MIN.
RMS-AEF-B-12W-24G-WW	ø100mm	Blanco Cálido 2700K	11cm	12W	780lm	24°	20u.	1u.
RMS-AEF-B-12W-36G-WW	ø100mm		11cm	12W	780lm	24°	20u.	1u.

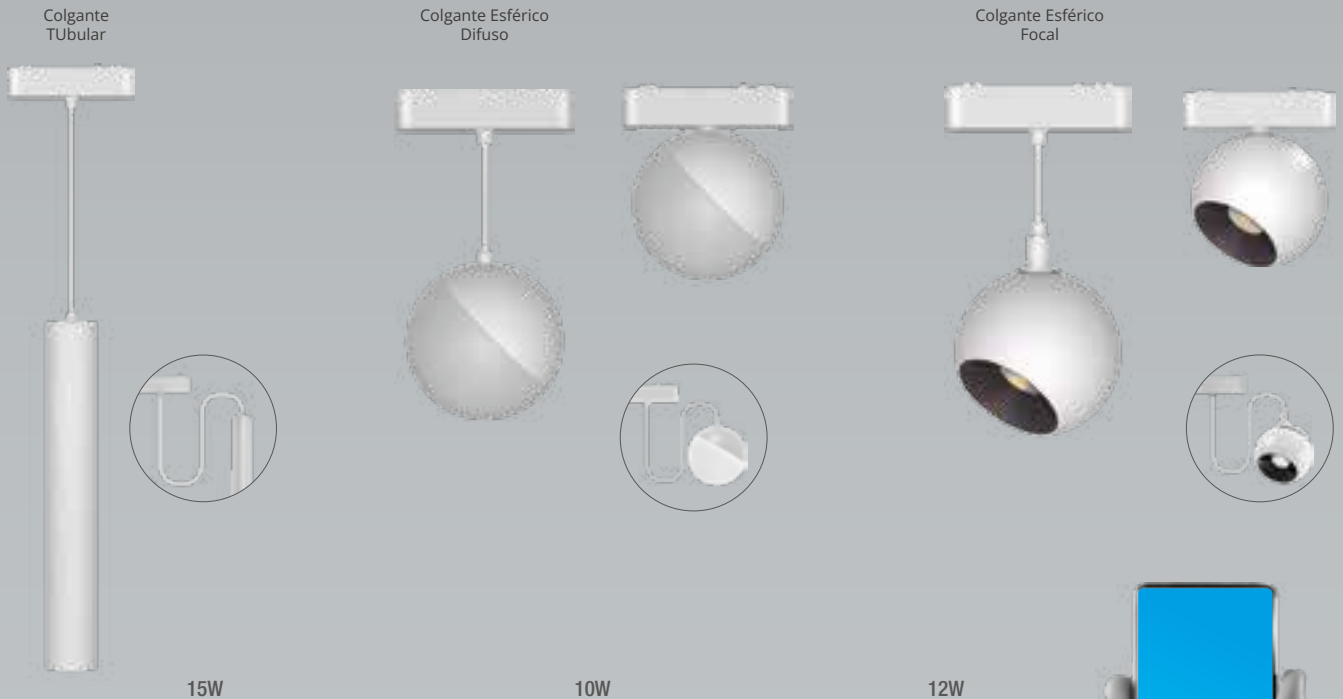

COLGANTE TUBULAR		TEMP.COLOR	LARGO	POTENCIA	LÚMENES	ÁNGULO	MASTER	VENTA MIN.
RMS-S-CC-B-15W-24G	ø45mm	2000K-5000K	100cm	15W	750lm	24°	30u.	1u.
RMS-S-CC-B-15W-36G	ø45mm	2000K-5000K	100cm	15W	750lm	36°	30u.	1u.

COLGANTE ESFÉRICO DIFUSO		TEMP.COLOR	LARGO	POTENCIA	LÚMENES	MASTER	VENTA MIN.
RMS-S-CED-B-10W	ø100mm	2000K-5000K	100cm	10W	700lm	20u.	1u.

APLIQUE ESFÉRICO DIFUSO		TEMP.COLOR	LARGO	POTENCIA	LÚMENES	MASTER	VENTA MIN.
RMS-S-AED-B-10W	ø100mm	2000K-5000K	11cm	10W	700lm	20u.	1u.

COLGANTE ESFÉRICO FOCAL		TEMP.COLOR	LARGO	POTENCIA	LÚMENES	MASTER	VENTA MIN.
RMS-S-CEF-B-12W	ø100mm	2000K-5000K	100cm	12W	780lm	20u.	1u.

APLIQUE ESFÉRICO FOCAL		TEMP.COLOR	LARGO	POTENCIA	LÚMENES	MASTER	VENTA MIN.
RMS-S-AEF-B-12W-24G	ø100mm	2000K-5000K	11cm	12W	780lm	20u.	1u.

APLIQUE TUBO DIFUSO
30cm



Colgante
Tubo flexible

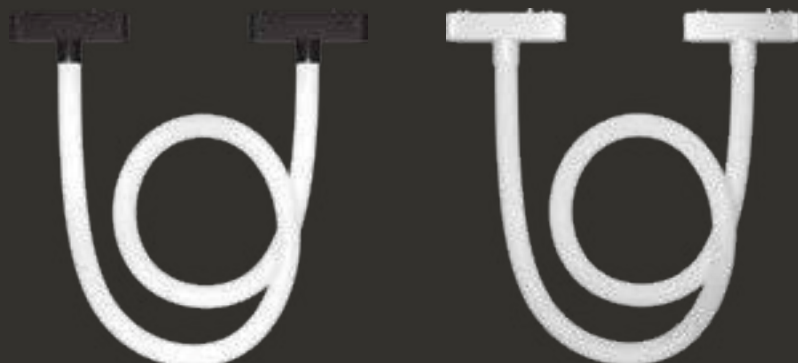

APLIQUE TUBO DIFUSO
60cm

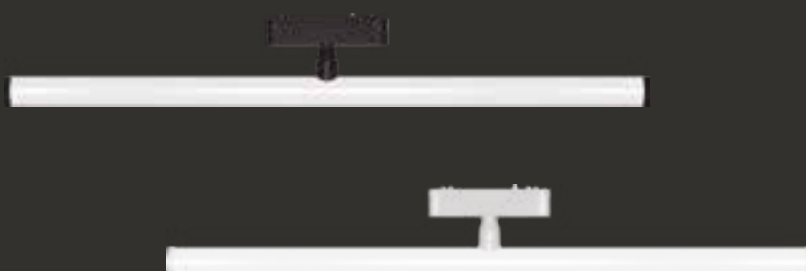

APLIQUE TUBO DIFUSO / NEGRO		TEMP.COLOR	LARGO	POTENCIA	LÚMENES	MASTER	VENTA MIN.
RMS-ATD302-N-6W-WW	ø28mm	Blanco	30cm	6W	600lm	20u.	1u.
RMS-ATD602-N-12W-WW	ø28mm	Cálido 2700K	60cm	12W	1500lm	20u.	1u.

APLIQUE TUBO DIFUSO / BLANCO		TEMP.COLOR	LARGO	POTENCIA	LÚMENES	MASTER	VENTA MIN.
RMS-ATD302-B-6W-WW	ø28mm	Blanco	30cm	6W	600lm	20u.	1u.
RMS-ATD602-B-12W-WW	ø28mm	Cálido 2700K	60cm	12W	1500lm	20u.	1u.

TUBO FLEXIBLE DIFUSO / NEGRO		TEMP.COLOR	LARGO	POTENCIA	LÚMENES	MASTER	VENTA MIN.
RMS-TF1000-N-10W-WW	ø22mm	Blanco	100cm	10W	600lm	10u.	1u.
RMS-TF2000-N-20W-WW	ø22mm	Cálido 2700K	200cm	20W	1500lm	10u.	1u.

TUBO FLEXIBLE DIFUSO / BLANCO		TEMP.COLOR	LARGO	POTENCIA	LÚMENES	MASTER	VENTA MIN.
RMS-TF1000-B-10W-WW	ø22mm	Blanco	100cm	10W	600lm	10u.	1u.
RMS-TF2000-B-20W-WW	ø22mm	Cálido 2700K	200cm	20W	1500lm	10u.	1u.

Fuente de Alimentación



Incluyen endcaps cubrecable



100W-48V

200W-48V



AC185-265V

FUENTE DE ALIMENTACIÓN	COLOR	MEDIDAS	POTENCIA	CORRIENTE	DIMERIZABLE	MASTER	VENTA MIN.
FRMS-100W-48V-NEG	Negro	290x25x27mm	100W	2.1A	No	50u.	50u.
FRMS-200W-48V-NEG	Negro	340x25x27mm	200W	4.2A	No	50u.	50u.
FRMS-100W-48V-BCO	Blanco	290x25x27mm	100W	2.1A	No	50u.	50u.
FRMS-200W-48V-BCO	Blanco	340x25x27mm	200W	4.2A	No	50u.	50u.
FRMS-DIM-100W-48V-NEG	Negro	290x25x27mm	100W	2.1A	Si	50u.	50u.
FRMS-DIM-200W-48V-NEG	Negro	340x25x27mm	200W	4.2A	Si	50u.	50u.
FRMS-DIM-100W-48V-BCO	Blanco	290x25x27mm	100W	2.1A	Si	50u.	50u.
FRMS-DIM-200W-48V-BCO	Blanco	340x25x27mm	200W	4.2A	Si	50u.	50u.





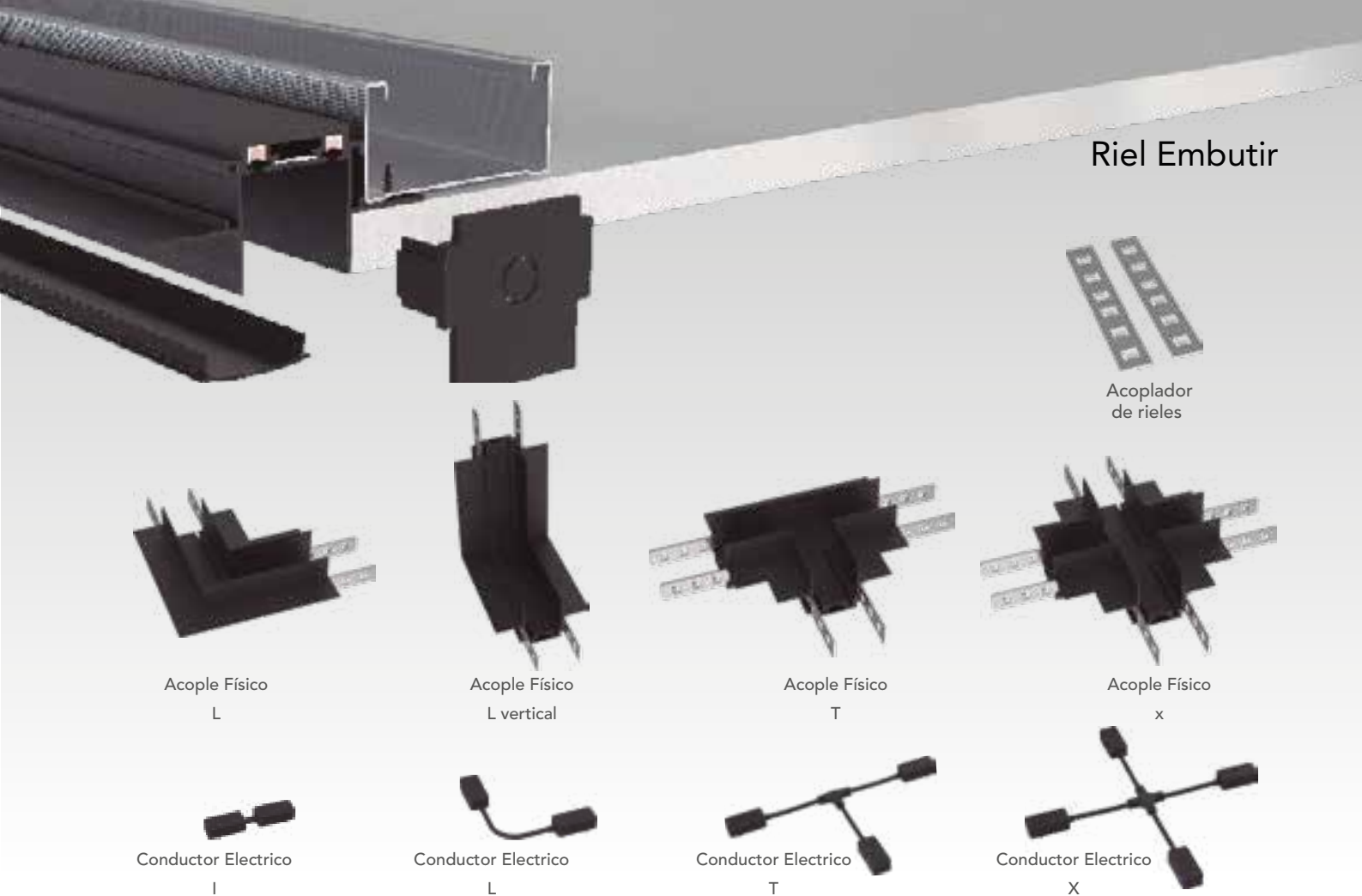

RIELES SLIM	COLOR	METROS	DESCRIPCIÓN	MASTER	VENTA MIN.
RMS-1M-B	● Blanco	1	Riel Magnético Skyline Macroled, DC48V C/ Endcap	40u.	4u.
RMS-1M-N	● Negro			40u.	4u.
RMS-2M-B	● Blanco	2	Riel Magnético Skyline Macroled, DC48V C/ Endcap	40u.	4u.
RMS-2M-N	● Negro			40u.	4u.
RMS-3M-B	● Blanco	3	Riel Magnético Skyline Macroled, DC48V C/ Endcap	40u.	4u.
RMS-3M-N	● Negro			40u.	4u.

ACCESORIOS	COLOR	DESCRIPCIÓN	MASTER	VENTA MIN.
RMS-CLR-B	● Blanco	 L Recto	100u.	2u.
RMS-CLR-N	● Negro	 L Recto	100u.	2u.
RMS-CLC-B	● Blanco	 L Curvo	100u.	2u.
RMS-CLC-N	● Negro	 L Curvo	100u.	2u.
RMS-CT-B	● Blanco	 T Recto	100u.	2u.
RMS-CT-N	● Negro	 T Recto	100u.	2u.
RMS-CX-B	● Blanco	 X Curvo	100u.	2u.
RMS-CX-N	● Negro	 X Curvo	100u.	2u.
RMS-CLV-B	● Blanco	 L Vertical	100u.	2u.
RMS-CLV-N	● Negro	 L Vertical	100u.	2u.
RMS-CPR-B	● Blanco	 Prolongador Recto	200u.	4u.
RMS-CPR-N	● Negro	 Prolongador Recto	200u.	4u.







Riel Embutir

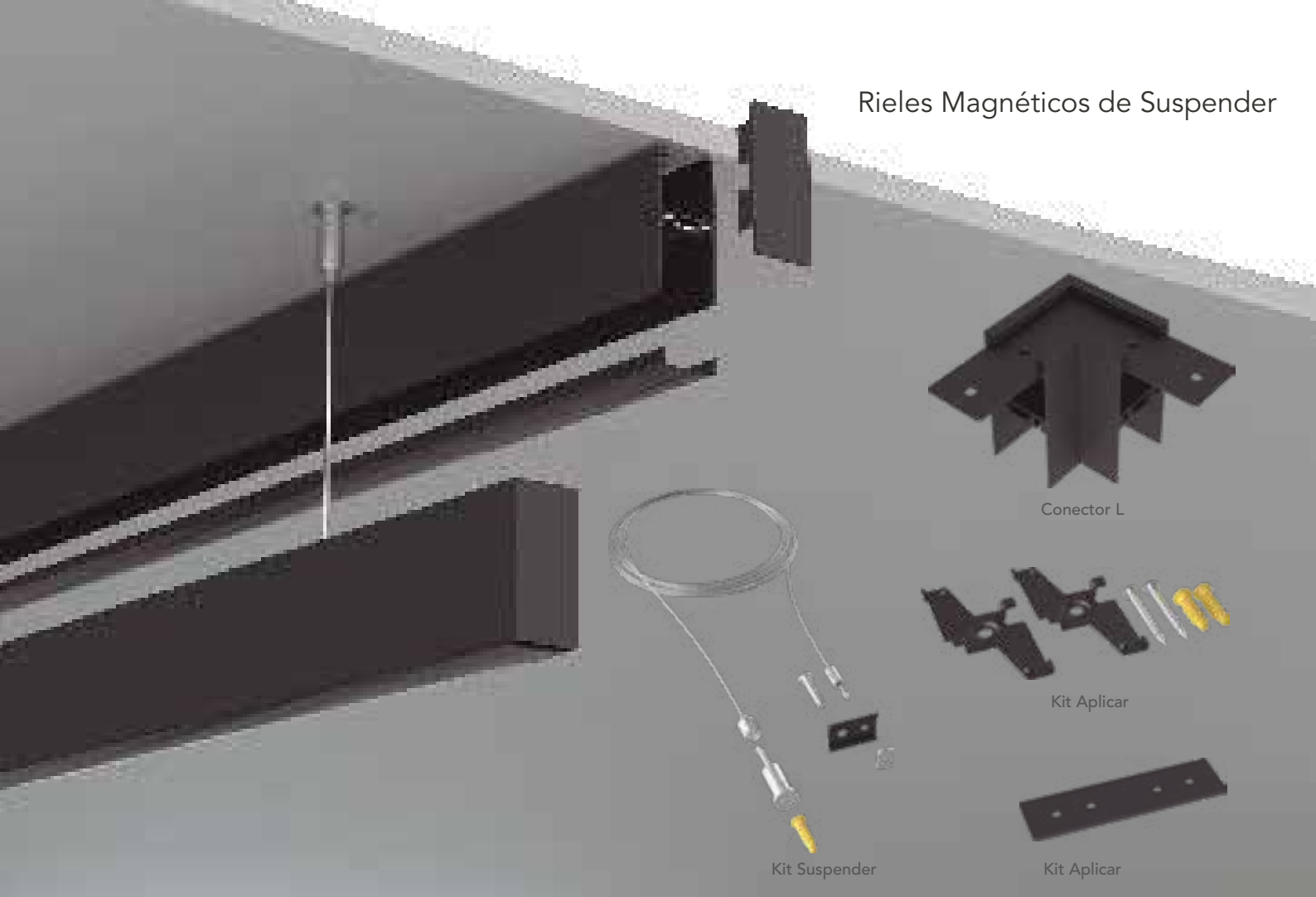





RIELES EMBUTIR	DESCRIPCIÓN	MASTER	VENTA MIN.
RMS-E-1M	 Riel de aluminio para embutir Skyline 1m, DC48V	10u.	10u.
RMS-E-2M	 Riel de aluminio para embutir Skyline 2m, DC48V	10u.	10u.
RMS-E-3M	 Riel de aluminio para embutir Skyline 3m, DC48V	10u.	10u.
RMS-AR-E	 Acoplador de rieles para riel magnético Skyline de embutir	800u.	1u.
RMS-CL-E	 Conector tipo L para riel magnético Skyline de embutir	50u.	1u.
RMS-CT-E	 Conector tipo T para riel magnético Skyline de embutir	50u.	1u.
RMS-CX-E	 Conector tipo X para riel magnetico Skyline de embutir	50u.	1u.
RMS-CLV-E	 Conector tipo L vertical para riel magnético Skyline de embutir	50u.	1u.

SUSPENDER / EMBUTIR	DESCRIPCIÓN	MASTER	VENTA MIN.
RMS-ELI-E-S	 Extensor de línea tipo I para riel magnético Skyline de embutir o suspensión DC48V	100u.	1u.
RMS-ETLL-E-S	 Extensor de línea tipo L para riel magnético Skyline de embutir o suspensión DC48V	100u.	1u.
RMS-ETLT-E-S	 Extensor de línea tipo T para riel magnético Skyline de embutir o suspensión DC48V	100u.	1u.
RMS-ETLX-E-S	 Extensor de línea tipo X para riel magnético Skyline de embutir o suspensión DC48V	100u.	1u.



RIELES SUSPENDER	DESCRIPCIÓN	MASTER	VENTA MIN.
RMS-S-1M	 Riel de aluminio para suspender Skyline 1m, DC48V	5u.	5u.
RMS-S-2M	 Riel de aluminio para suspender Skyline 2m, DC48V	5u.	5u.
RMS-S-3M	 Riel de aluminio para suspender Skyline 3m, DC48V	-	-
RMS-AR-S	 Acoplador de rieles para riel magnético Skyline de suspensión	400u.	1u.
RMS-CL-S	 Conector tipo L para riel magnético Skyline de suspensión	50u.	1u.
RMS-S-S	 Suspendor de rieles para riel magnético Skyline 2x2 metros	100u.	Intermed.
RMS-A-S	 Kit Aplicar para riel magnético Skyline	XXu.	Xu.

SUSPENDER / EMBUTIR	DESCRIPCIÓN	MASTER	VENTA MIN.
RMS-ELI-E-S	 Extensor de línea tipo I para riel magnético Skyline de embutir o suspensión DC48V	100u.	1u.
RMS-ETLL-E-S	 Extensor de línea tipo L para riel magnético Skyline de embutir o suspensión DC48V	100u.	1u.
RMS-ETLT-E-S	 Extensor de línea tipo T para riel magnético Skyline de embutir o suspensión DC48V	100u.	1u.
RMS-ETLX-E-S	 Extensor de línea tipo X para riel magnético Skyline de embutir o suspensión DC48V	100u.	1u.



PROTECCIÓN UV
Cobertura Anti UV. No se daña el color por la exposición al sol



APTO EXTERIORES
Con Protección IP54 certificado apto para la intemperie y mal clima



MULTIVOLTAJE
Gran versatilidad en su funcionamiento AC100-265V

TORTUGA LED BLANCA REDONDA					MEDIDAS	FP	LM X W	MASTER	VENTA MIN.
TR-MB-12W-WW	12W	Cálido	3000°K	1080lm	140x50mm	0.95	90	40u.	5u.
TR-MB-12W-CW	12W	Frío	6500°K	1080lm	140x50mm	0.95	90	40u.	5u.
TR-MB-18W-WW	18W	Cálido	3000°K	1620lm	175x50mm	0.95	90	40u.	5u.
TR-MB-18W-CW	18W	Frío	6500°K	1680lm	175x50mm	0.95	90	40u.	5u.



TORTUGA LED BLANCA OVAL					MEDIDAS	FP	LM X W	MASTER	VENTA MIN.
TO-MB-12W-WW	12W	Cálido	3000°K	1080lm	16x4,7x8,7mm	0.95	90	40u.	5u.
TO-MB-12W-CW	12W	Frío	6500°K	1080lm	16x4,7x8,7mm	0.95	90	40u.	5u.
TO-MB-18W-WW	18W	Cálido	3000°K	1620lm	19,5x4,8x9,7mm	0.95	90	40u.	5u.
TO-MB-18W-CW	18W	Frío	6500°K	1680lm	19,5x4,8x9,7mm	0.95	90	40u.	5u.



TORTUGA LED NEGRA REDONDA					MEDIDAS	FP	LM X W	MASTER	VENTA MIN.
TR-MN-12W-WW	12W	Cálido	3000°K	1080lm	140x50mm	0.95	90	40u.	5u.
TR-MN-12W-CW	12W	Frío	6500°K	1080lm	140x50mm	0.95	90	40u.	5u.
TR-MN-18W-WW	18W	Cálido	3000°K	1620lm	175x50mm	0.95	90	40u.	5u.
TR-MN-18W-CW	18W	Frío	6500°K	1680lm	175x50mm	0.95	90	40u.	5u.



TORTUGA LED NEGRA OVAL					MEDIDAS	FP	LM X W	MASTER	VENTA MIN.
TO-MN-12W-WW	12W	Cálido	3000°K	1080lm	16x4,7x8,7mm	0.95	90	40u.	5u.
TO-MN-12W-CW	12W	Frío	6500°K	1080lm	16x4,7x8,7mm	0.95	90	40u.	5u.
TO-MN-18W-WW	18W	Cálido	3000°K	1620lm	19,5x4,8x9,7mm	0.95	90	40u.	5u.
TO-MN-18W-CW	18W	Frío	6500°K	1680lm	19,5x4,8x9,7mm	0.95	90	40u.	5u.



ESTACA LED 5W / ø56x265 mm					MATERIAL	PROTECCIÓN	MASTER	VENTA MIN
ELP-5W-IP65-WW	Cálido	3000°K	420lm	84lm/W	PP/ Nylon	IP65	60u.	10u.
ELP-5W-IP65-NW	Neutro	4500°K	420lm	84lm/W	PP/ Nylon	IP65	60u.	10u.

ESTACA LED 7W / ø75x230 mm					MATERIAL	PROTECCIÓN	MASTER	VENTA MIN
ELAC-7W-IP65-WW	Cálido	3000°K	580lm	84lm/W	Aluminio	IP65	40u.	10u.
ELAC-7W-IP65-NW	Neutro	4500°K	580lm	84lm/W	Aluminio	IP65	40u.	10u.

ESTACA GU10 / ø98x322mm		APLIQUE	MATERIAL	PROTECCIÓN	MASTER	VENTA MIN
EDGU10-IP65	35W Máx	Suelo / Pared	Aluminio	IP65/IK07	40u.	10u.

ESTACA / 35x145mm	MEDIDAS	APLIQUE	MATERIAL	MASTER	VENTA MIN.
EA-145MM	35X145 mm	Suelo	Aluminio	200u.	10u.



ESTACA SOLAR X1 2W / 106x165x300 mm					AUTONOMÍA	PROTECCIÓN	MASTER	VENTA MIN.
ELSX1-2W-IP65-WW	Cálido	3000°K	150/250lm	6hs.	IP65	30u.	5u.	
ELSX1-2W-IP65-CW	Frío	6500°K	150/250lm	6hs.	IP65	30u.	5u.	

ESTACA SOLAR X2 1W / 152x105x45 mm					AUTONOMÍA	PROTECCIÓN	MASTER	VENTA MIN.
ELSX2-2W-IP65-WW	Cálido	3000°K	300/500lm	12-14hs.	IP65	12u.	-	

ESTACA SOLAR X4 1W / 300x105x48 mm					AUTONOMÍA	PROTECCIÓN	MASTER	VENTA MIN.
ELSX4-4W-IP65-WW	Cálido	3000°K	200/320lm	12-14hs.	IP65	6u.	-	



ASPSM-5W-IP65



FOTOCÉLULA
El artefacto se enciende en ausencia de la luz ambiente



Batería de Litio
3.7V/2200mAh

ASPSM-10W-IP65



FOTOCÉLULA
El artefacto se enciende en ausencia de la luz ambiente



Baterías de Litio x2
3.7V/2200mAh

ASP-1.5W-IP54



FOTOCÉLULA
El artefacto se enciende en ausencia de la luz ambiente



Batería de Litio
3.7V/1800mAh

1

Se enciende al 100% al detectar movimiento. Se apaga luego de 30 seg. de inactividad.

2

Se enciende al 50% constante, ante la ausencia de luz ambiente y sin función de movimiento.

3

Se enciende al 50%. Al detectar movimiento, pasa al 100% y vuelve al estado anterior luego de 30 seg. de inactividad.

*Aplicable a los modelos ASPSM de 5W y 10W

LUZ DE PARED 1.5W SOLAR / 94x122x48mm			AUTONOMÍA	PROTECCIÓN	MASTER	VENTA MIN.	
ASP-1.5W-IP54WW	Cálido	3000°K	50lm	9hs.	IP54	80u.	10u.
ASP-1.5W-IP54CW	Frío	6500°K	50lm	9hs.	IP54	80u.	10u.

LUZ DE PARED 5W SOLAR / 152x105x45mm				AUTONOMÍA	PROTECCIÓN	MASTER	VENTA MIN.
ASPSM-5W-IP65-WW	Cálido	3000°K	300/500lm	8-10hs.	IP65	48u.	6u.
ASPSM-5W-IP65-CW	Frío	6500°K	300/500lm	8-10hs.	IP65	48u.	6u.

LUZ DE PARED 10W SOLAR / 300x105x48mm				AUTONOMÍA	PROTECCIÓN	MASTER	VENTA MIN.
ASPSM-10W-IP65-WW	Cálido	3000°K	600/1000lm	8-10hs.	IP65	24u.	6u.
ASPSM-10W-IP65-CW	Frío	6500°K	600/1000lm	8-10hs.	IP65	24u.	6u.

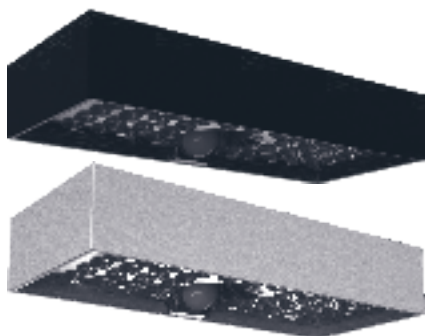

SSLL-6W-N / SSLL-6W-B

Batería de Litio
3.7V/3000mAh



SSFL-5W

Batería de Litio
3.7V/3000mAh



SSFL-10W

Baterías de Litio 3x
7.4V/3000mAh



SSFLM-10W

Batería de Litio
3.7V/7200mAh



AHORRO ENÉRGICO

Producto con batería de litio recargable con energía solar.

ENCENDIDO INSTANTÁNEO

Enciende al 100% de su capacidad lumínica instantáneamente.

SIN RUIDOS NI PARPADEOS

No produce luz intermitente ni ruidos molestos.

FOTOCÉLULA

El artefacto se enciende en ausencia de la luz ambiente

PROTECCIÓN IP65

Equipo resistente a salpicaduras de agua y a prueña de polvo.

PRODUCTO ECOLÓGICO

Producto libre de materiales tóxicos. La energía solar no causa contaminación.

DE BAJO MANTENIMIENTO

Apenas se necesita limpiar los paneles con un paño con agua y jabón.

ARTEFACTO DE PARED SOLAR 6W / 230x97x43 mm				AUTONOMÍA	PROTECCIÓN	MASTER	VENTA MIN.
SSLL-6W-B-WW	Cálido	3000°K	800lm	2 a 4 noches (20-40hs) según el modo (baja/alta)	IP65	24u.	24u.
SSLL-6W-N-WW	Cálido	3000°K	800lm		IP65	24u.	24u.

REFLECTOR SOLAR 5W / 240x162x40mm				AUTONOMÍA	PROTECCIÓN	MASTER	VENTA MIN.
SSFL-5W-WW	Cálido	3000°K	500lm	1 noche (luz constante)	IP65	18u.	18u.
SSFL-5W-CW	Frío	6000°K	500lm	a 5 noches (con sensor)	IP65	18u.	18u.

REFLECTOR SOLAR 10W / 560x340x245mm				AUTONOMÍA	PROTECCIÓN	MASTER	VENTA MIN.
SSFL-10W-WW	Cálido	3000°K	1150lm	6-50hs.	IP65	8u.	8u.
SSFL-10W-CW	Frío	6000°K	1150lm	6-50hs.	IP65	8u.	8u.

REFLECTOR SOLAR 10 W / 345x236x25 mm				AUTONOMÍA	PROTECCIÓN	MASTER	VENTA MIN.
SSFLM-10W-WW	Cálido	3000°K	1100lm	6-30hs.	IP65	10u.	10u.
SSFLM-10W-CW	Frío	6000°K	1100lm	6-30hs.	IP65	10u.	10u.



SSSL-15W-CW

Batería de Litio
7.4V/5400mAh



SSSL-40W-CW



Batería de Litio
12.8V/6000mAh



FOTOCÉLULA

El artefacto se enciende en ausencia de la luz ambiente

PRODUCTO ECOLÓGICO

Producto libre de materiales tóxicos. La energía solar no causa contaminación.

AHORRO ENERGÉTICO

Producto con batería de litio recargable con energía solar.

ENCENDIDO INSTANTÁNEO

Enciende al 100% de su capacidad luminica instantáneamente.

SIN RUIDOS NI PARPADEOS

No produce luz intermitente ni ruidos molestos.

PROTECCIÓN IP65

Equipo resistente a salpicaduras de agua y a prueba de polvo.

DE BAJO MANTENIMIENTO

Apenas se necesita limpiar los paneles con un paño con agua y jabón.

LUZ DE CALLE SOLAR / 493x232x58 mm				AUTONOMÍA	PROTECCIÓN	MASTER	VENTA MIN.
SSSL-15W-CW	Frío	6000°K	1600lm	6-50hs (1-5 noches)	IP65	8u.	8u.

LUZ DE CALLE SOLAR / 706x290x74 mm				AUTONOMÍA	PROTECCIÓN	MASTER	VENTA MIN.
SSSL-40W-CW	Frío	6000°K	4800lm	6-30hs (1-3 noches)	IP65	4u.	4u.

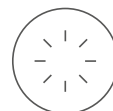

Eficiencia lumínica de 90lm/W



Válvula Anti-Humedad

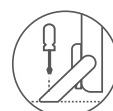

Fácil Colocación



REFLECTOR 10W / IP65 / AC100-240V / 95° / 125x104x27mm					VIDA ÚTIL	MASTER
FLSV2-10WW	Cálido	3000°K	900lm	90 lm/W	50.000hs	20u.
FLSV2-10CW	Frío	6500°K	900lm	90 lm/W	50.000hs	20u.



REFLECTOR 20W / IP65 / AC100-240V / 95° / 152x125x28mm					VIDA ÚTIL	MASTER
FLSV2-20WW	Cálido	3000°K	1800lm	90 lm/W	50.000hs	20u.
FLSV2-20CW	Frío	6500°K	1800lm	90 lm/W	50.000hs	20u.



REFLECTOR 30W / IP65 / AC100-240V / 95° / 168x209x30mm					VIDA ÚTIL	MASTER
FLSV2-30WW	Cálido	3000°K	2700lm	90 lm/W	50.000hs	20u.
FLSV2-30CW	Frío	6500°K	2700lm	90 lm/W	50.000hs	20u.



REFLECTOR BLANCO 30W / IP65 / AC100-240V / 95° / 168x209x30mm					VIDA ÚTIL	MASTER
BFLSV2-30WW	Cálido	3000°K	2700lm	90 lm/W	50.000hs	20u.
BFLSV2-30CW	Frío	6500°K	2700lm	90 lm/W	50.000hs	20u.



REFLECTOR BLANCO 30W / IP65 / AC100-240V / 95° / 168x209x30mm					VIDA ÚTIL	MASTER
FLSV2-50WW	Cálido	3000°K	4500lm	90 lm/W	50.000hs	12u.
FLSV2-50CW	Frío	6500°K	4500lm	90 lm/W	50.000hs	12u.



REFLECTOR BLANCO 50W / IP65 / AC100-240V / 95° / 200x237x36mm					VIDA ÚTIL	MASTER
BFLSV2-50WW	Cálido	3000°K	4500lm	150 lm/W	50.000hs	12u.
BFLSV2-50CW	Frío	6500°K	4500lm	150 lm/W	50.000hs	12u.

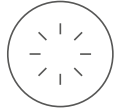

Eficiencia
luminica de 110lm/W



Válvula
Anti-Humedad



Fácil Colocación



REFLECTOR 100W / IP65 / AC100-240V / 95° / 343x302x45mm					VIDA ÚTIL	MASTER
FLSV2-100WW	Cálido	3000°K	11.000lm	110 lm/W	50.000hs	4u.
FLSV2-100CW	Frío	6500°K	11.000lm	110 lm/W	50.000hs	4u.
REFLECTOR 150W / IP65 / AC100-240V / 95° / 443x351x58mm					VIDA ÚTIL	MASTER
FLSV2-150WW	Cálido	3000°K	16.500lm	110 lm/W	50.000hs	2u.
FLSV2-150CW	Frío	6500°K	16.500lm	110 lm/W	50.000hs	2u.
REFLECTOR 200W / IP65 / AC100-240V / 95° / 493x400x58mm					VIDA ÚTIL	MASTER
FLSV2-200WW	Cálido	3000°K	22.000lm	110 lm/W	50.000hs	2u.
FLSV2-200CW	Frío	6500°K	22.000lm	110 lm/W	50.000hs	2u.
REFLECTOR 400W / IP65 / AC100-240V / 95° / 599x442x62mm					VIDA ÚTIL	MASTER
FLSV2-400CW	Frío	6500°K	52.000lm	130 lm/W	50.000hs	1u.



C Sensor de luz
(Modo de operación: día o noche)

B Timer de encendido
(Tiempo de encendido de 10 segundos a 10 minutos)

A Sensor de movimiento
(Sensor de sensibilidad ajustable)



REFLECTOR 20W / IP65 / AC100-240V / 95°/ 159x125x55mm					VIDA ÚTIL	MASTER
SFLSV2-20WW	Cálido	3000°K	1800lm	90 lm/W	50.000hs	10u.
SFLSV2-20CW	Frío	6500°K	1800lm	90 lm/W	50.000hs	10u.



REFLECTOR 30W / IP65 / AC100-240V / 95°/ 168x252x54mm					VIDA ÚTIL	MASTER
SFLSV2-30WW	Cálido	3000°K	2700lm	90 lm/W	50.000hs	10u.
SFLSV2-30CW	Frío	6500°K	2700lm	90 lm/W	50.000hs	10u.



REFLECTOR 50W / IP65 / AC100-240V / 95°/ 200x237x57mm					VIDA ÚTIL	MASTER
SFLSV2-50WW	Cálido	3000°K	4500lm	90 lm/W	50.000hs	6u.
SFLSV2-50CW	Frío	6500°K	4500lm	90 lm/W	50.000hs	6u.



IP65/IK05
Protección Superior



Mayor Eficacia
Factor de Potencia Superior 0.5



Válvula
NUEVO: Válvula de humedad en modelos de 20 a 200



SAMSUNG LED
Con chip Samsung, marca líder en el mercado



25.000hs
Vida útil extendida



Brazo 45°
Diseñado para su fácil y rápida colocación.



REFLECTOR 10W / IP65 / AC220-240V / 110° / 105x70x25 mm					VIDA ÚTIL	MASTER
EFL-10W-WW	Cálido	3000°K	800lm	80lm/W	25.000hs	60u.
EFL-10W-CW	Frío	6500°K	800lm	80lm/W	25.000hs	60u.



REFLECTOR 20W / IP65 / AC220-240V / 110° / 152x125x28mm					VIDA ÚTIL	MASTER
EFL-20W-WW	Cálido	3000°K	1.600lm	80lm/W	25.000hs	50u.
EFL-20W-CW	Frío	6500°K	1.600lm	80lm/W	25.000hs	50u.



REFLECTOR 30W / IP65 / AC220-240V / 110° / 168x209x30mm					VIDA ÚTIL	MASTER
EFL-30W-WW	Cálido	3000°K	2.400lm	80lm/W	25.000hs	30u.
EFL-30W-CW	Frío	6500°K	2.400lm	80lm/W	25.000hs	30u.



REFLECTOR 50W / IP65 / AC220-240V / 110° / 200x237x36mm					VIDA ÚTIL	MASTER
EFL-50W-WW	Cálido	3000°K	4.000lm	80lm/W	25.000hs	30u.
EFL-50W-CW	Frío	6500°K	4.000lm	80lm/W	25.000hs	30u.



IP65/IK05
Protección Superior



Mayor Eficacia
Factor de Potencia Superior 0.5



Válvula
NUEVO: Válvula de humedad en modelos de 20 a 200



SAMSUNG LED
Con chip Samsung, marca líder en el mercado



25.000hs
Vida útil extendida



Brazo 45°
Diseñado para su fácil y rápida colocación.



REFLECTOR 100W / IP65 / AC100-240V / 110° / 245x180x36 mm					VIDA ÚTIL	MASTER
EFL-100W-WW	Cálido	3000°K	9.000lm	90 lm/W	25.000hs	5u.
EFL-100W-CW	Frío	6500°K	9.000lm	90 lm/W	25.000hs	5u.



REFLECTOR 150W / IP65 / AC100-240V / 110° / 375x280x38mm					VIDA ÚTIL	MASTER
EFL-150W-WW	Cálido	3000°K	13.500lm	90 lm/W	25.000hs	5u.
EFL-150W-CW	Frío	6500°K	13.500lm	90 lm/W	25.000hs	5u.



REFLECTOR 200W / IP65 / AC100-240V / 110° / 410x298x40mm					VIDA ÚTIL	MASTER
EFL-200W-WW	Cálido	3000°K	18.000lm	90 lm/W	25.000hs	4u.
EFL-200W-CW	Frío	6500°K	18.000lm	90 lm/W	25.000hs	4u.



REFLECTOR 300W / IP65 / AC100-240V / 110° / 538x379x48mm					VIDA ÚTIL	VENTA MÍN.	MASTER
EFL-300W-WW	Cálido	3000°K	30.000lm	100lm/W	25.000hs	1u.	4u.
EFL-300W-CW	Frío	6500°K	30.000lm	100lm/W	25.000hs	1u.	4u.



300W - 60°



400W - 60°



600W - 30° / 600W - 60°



800W - 60°



1000W - 60°



IP66/IK08
Protección Superior



ANTIHIGHVOLT
Protección contra
sobre-tensiones de 1500V



0.9
Mayor Eficacia
Factor de Potencia
Superior 0.9



50.000hs
Vida útil extendida



140lm/Watt
Eficacia lumínica
Mejorada



DRIVER
Sosen



Ángulo de
apertura
Reducido con Julior precisión

REFLECTORES TITAN								MÁSTER
FLSP-300-60G-CW	300W	AC100-277V	Frío	5700°K	522x370x152mm	140 lm/W	50.000hs	1u.
FLSP-400-60G-CW	400W	AC100-277V	Frío	5700°K	522x466x152mm	140 lm/W	50.000hs	1u.
FLSP-600-30G-CW	600W	AC100-277V	Frío	5700°K	575x700x152mm	140 lm/W	50.000hs	1u.
FLSP-600-60G-CW	600W	AC100-277V	Frío	5700°K	575x700x152mm	140 lm/W	50.000hs	1u.
FLSP-800-60G-CW	800W	AC100-277V	Frío	5700°K	974x612x177mm	140 lm/W	50.000hs	1u.
FLSP-1000-60G-CW	1000W	AC100-277V	Frío	5700°K	974x707x177mm	140 lm/W	50.000hs	1u.

IVA 21%



500W - 60°



1000W - 60°



SPD 6KV
Gran protección
contra sobretensiones



120lm/W
Eficiencia Lumínica
Superior



THD <15%
Driver premium con
Reducción de interferencias



IP65/IK08
Protección Superior

REFLECTORES OLIMPUS	POTENCIA	TENSIÓN	TEMPERATURA		MEDIDAS	LÚMENES	MÁSTER
OLIMPUS-500W-60G-CW	500W	AC100-277V	Frío	6500°K	530x65x523mm	60000lm	1u.
OLIMPUS-1000W-60G-CW	1000W	AC100-277V	Frío	6500°K	1022x65x525mm	120000lm	1u.



**IK08
IP65** IP65/IK08
Protección Superior

ANTIHIGHVOLT
Protección contra sobre-
tensiones de 1500V

140lm/Watt
Eficacia luminica
Mejorada

FUENTE MEANWELL
Multivoltaje 100-240V

0.9 Mayor Eficacia
Factor de Potencia
Superior 0.9

100.000hs
Vida útil extendida



REFLECTOR 240W / IP65 / AC100-240V / 90° / 341x425x68mm					VIDA ÚTIL	MASTER
FL240DRWW	Cálido	3000°K	33600lm	140 lm/W	100.000hs	1u.
FL240DRCW	Frío	5700°K	33600lm	140 lm/W	100.000hs	1u.



**IK08
IP65** IP65/IK08
Protección Superior
Aptas para vía pública

140lm/Watt
Eficacia luminica
Mejorada

0.9 Mayor Eficacia
Factor de Potencia
Superior 0.9

ANTIHIGHVOLT
Protección contra sobre-
tensiones de 1500V

SAMSUNG LED
Con chip Samsung, marca
líder en el mercado

50.000hs
Vida útil extendida

HIGHBAY 100W	POTENCIA	/ AC100-240V / 230x160mm				VIDA ÚTIL	MASTER
HBV2100P	100W	Frío	6500°K	14000lm	140lm/W	50000hs	4u.
HIGHBAY 150W	POTENCIA	/ AC100-240V / 310x165mm				VIDA ÚTIL	MASTER
HBV2150P	150W	Frío	6500°K	21000lm	140lm/W	50000hs	2u.
HIGHBAY 200W	POTENCIA	/ AC100-240V / 400x177mm				VIDA ÚTIL	MASTER
HBV2200P	200W	Frío	6500°K	28000lm	140lm/W	50000hs	2u.



IP65/IK08
Protección Superior
Aptas para vía pública



ANTIHIGHVOLT
Protección contra
sobretensiones de 1500V



Mayor Eficacia
Factor de Potencia
Superior 0.9



CÁNCAMO
Incluido



SANAN SMD3030
Con chip Samsung, marca
líder en el mercado



25.000hs
Vida útil extendida

HIGHBAY 100W	POTENCIA	/ AC180-240V / 260x35mm				VIDA ÚTIL	MASTER
EHB-100W-CW	100W	Frío	5700°K	10000lm	100lm/W	25000hs	5u.
HIGHBAY 150W	POTENCIA	/ AC180-240V / 310x35mm				VIDA ÚTIL	MASTER
EHB-150W-CW	150W	Frío	5700°K	15000lm	100lm/W	25000hs	5u.
HIGHBAY 200W	POTENCIA	/ AC180-240V / 345x35mm				VIDA ÚTIL	MASTER
EHB-200W-CW	200W	Frío	5700°K	20000lm	100lm/W	25000hs	5u.

BRAZO PARA HIGHBAY	POTENCIA	MEDIDAS	INTERMEDIA	MASTER
EHB-BR	100W / 150W / 200W	31.5x24x16cm	5u.	20u.



IP65/IK08
Protección Superior



ANTIHIGHVOLT
Protección contra sobre-
tensiones de 1500V



120lm/Watt
Eficacia luminica
Mejorada



SEOUL LED
Con chip Seoul, marca
líder en el mercado



0.9
Mayor Eficacia
Factor de Potencia
Superior 0.9



Certificado IRAM
Seguridad Eléctrica
bajo norma IEC

50W

100W / 150W

200W

LUMINARIA PÚBLICA 50W / IP65 / AC100-265V / 380x160X41mm					VIDA ÚTIL	MASTER
SL-50-CW	Frío	5700°K	6000lm	120 lm/W	50000hs	6u.
LUMINARIA PÚBLICA 100W / IP65 / AC100-265V / 480x230X47mm					VIDA ÚTIL	MASTER
SL-100-CW	Frío	5700°K	12000lm	120 lm/W	50000hs	4u.
LUMINARIA PÚBLICA 150W / IP65 / AC100-265V / 480x230X48mm					VIDA ÚTIL	MASTER
SL-150-CW	Frío	5700°K	18000lm	120 lm/W	50000hs	4u.
LUMINARIA PÚBLICA 200W / IP65 / AC100-240V / 542x262x86mm					VIDA ÚTIL	MASTER
SL-200-CW	Frío	5700°K	24000lm	120 lm/W	50000hs	3u.



IP65/IK08
Protección Superior



ANTIHIGHVOLT
Protección contra sobre-
tensiones de 1500V



120lm/Watt
Eficacia luminica
Mejorada



SAMSUNG LED
Con chip Samsung, marca
líder en el mercado



0.9
Mayor Eficacia
Factor de Potencia
Superior 0.9



Certificado IRAM
Seguridad Eléctrica
bajo norma IEC

FAROLA 50W / IP65 / AC100-240V / Ø377x375mm					VIDA ÚTIL	MASTER
FPL-50W-WW	Cálido	3000°K	6000lm	120 lm/W	30000hs	1u.
FPL-50W-CW	Frío	5700°K	6000lm	120 lm/W	30000hs	1u.

FAROLA 100W / IP65 / AC100-240V / Ø377x375mm					VIDA ÚTIL	MASTER
FPL-100W-WW	Cálido	3000°K	12000lm	120 lm/W	30000hs	1u.
FPL-100W-CW	Frío	5700°K	12000lm	120 lm/W	30000hs	1u.

FAROLA 140W / IP65 / AC100-240V / Ø377x375mm					VIDA ÚTIL	MASTER
FPL-140W-WW	Cálido	3000°K	16800lm	120 lm/W	30000hs	1u.
FPL-140W-CW	Frío	5700°K	16800lm	120 lm/W	30000hs	1u.

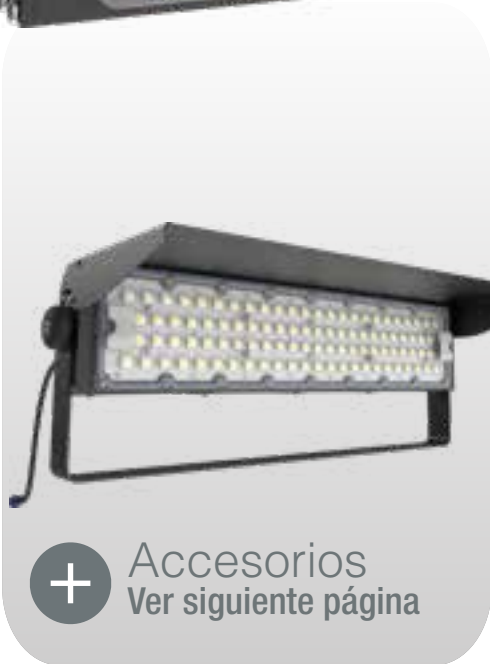

Protector SPD 10KV absorbe picos de hasta 10.000 voltios



IP66/IK08 Protección Superior



Ángulos de aperturas



ANTIHIGHVOLT Protección contra sobretensiones de 1500V



Mayor Eficacia Factor de Potencia Superior 0.95



Cuerpo de Aluminio



170lm/Watt Eficacia luminica Mejorada



100.000hs Vida útil extendida

REFLECTORES FOCUS	APERTURA	TENSIÓN		TEMPERATURA		MEDIDAS	LÚMENES	VIDA ÚTIL	MASTER
FOCUS-250W-20G-CW	20°	250W	AC100-240V	Frío	5700°K	550x122x127mm	170 lm/W	100.000hs	4u.
FOCUS-250W-40G-CW	40°	250W	AC100-240V	Frío	5700°K	550x122x127mm	170 lm/W	100.000hs	4u.
FOCUS-250W-60G-CW	60°	250W	AC100-240V	Frío	5700°K	550x122x127mm	170 lm/W	100.000hs	4u.
FOCUS-250W-90G-CW	90°	250W	AC100-240V	Frío	5700°K	550x122x127mm	170 lm/W	100.000hs	4u.
FOCUS-250W-ASIM-CW	ASIMÉTRICO	250W	AC100-240V	Frío	5700°K	550x122x127mm	170 lm/W	100.000hs	4u.



CONECTOR INCLUIDO
Para una instalación más rápida y segura.



Cuerpo de aluminio
Garantiza durabilidad ante condiciones adversas.



5 años de garantía



(*) Todos los brazos incluyen
Protector SPD 20KV
Absorbe picos de hasta 20.000 voltios



X1 FOCUS-BR-250W



X2 FOCUS-BR-500W



X3 FOCUS-BR-750W



X4 FOCUS-BR-1000W



FOCUS-VAE



FOCUS-L-500M

REFLECTORES FOCUS	DESCRIPCIÓN	CAJA MÁSTER
FOCUS-BR-250W	Soporta 1 módulo de cualquier ángulo de apertura.	24u.
FOCUS-BR-500W	Soporta 2 módulos de cualquier ángulo de apertura.	6u.
FOCUS-BR-750W	Soporta 3 módulos de cualquier ángulo de apertura.	6u.
FOCUS-BR-1000W	Soporta 4 módulos de cualquier ángulo de apertura.	6u.
FOCUS-VAE	-	24u.
FOCUS-L-500M	Alcance de 500 mts. máximo. Batería de litio 16340.	200u.



TIRA 2835 / 60 LED X METRO / IP20 / 12V					VIDA ÚTIL	MASTER	VENTA MIN
WW-C300-FW12-IP20	Cálido	2700°K	12WxM	1.030 lmxM	50000hs.	50u.	1u.
CW-C300-FW12-IP20	Frío	6000°K	12WxM	1.080 lmxM	50000hs.	50u.	1u.
R-C300-FW12-IP20	Rojo	625 NM	8WxM	180 lmxM	50000hs.	50u.	1u.
G-C300-FW12-IP20	Verde	520 NM	8WxM	960 lmxM	50000hs.	50u.	1u.
B-C300-FW12-IP20	Azul	460 NM	8WxM	120 lmxM	50000hs.	50u.	1u.
Y-C300-FW12-IP20	Amarillo	585 NM	8WxM	180 lmxM	50000hs.	50u.	1u.

TIRA 2835 / 60 LED X METRO / IP45 / 12V					VIDA ÚTIL	MASTER	VENTA MIN
WW-C300-FW12-IP45	Cálido	2700°K	12WxM	1.030 lmxM	50000hs.	50u.	1u.
CW-C300-FW12-IP45	Frío	6000°K	12WxM	1.080 lmxM	50000hs.	50u.	1u.
R-C300-FW12-IP45	Rojo	625 NM	8WxM	180 lmxM	50000hs.	50u.	1u.
G-C300-FW12-IP45	Verde	520 NM	8WxM	960 lmxM	50000hs.	50u.	1u.
B-C300-FW12-IP45	Azul	460 NM	8WxM	120 lmxM	50000hs.	50u.	1u.
Y-C300-FW12-IP45	Amarillo	585 NM	8WxM	180 lmxM	50000hs.	50u.	1u.

TIRA 2835 / 60 LED X METRO / IP66 / 12V					VIDA ÚTIL	MASTER	VENTA MIN
WW-C300-FW12-IP66	Cálido	2700°K	12WxM	1.030 lmxM	50000hs.	50u.	1u.
CW-C300-FW12-IP66	Frío	6000°K	12WxM	1.080 lmxM	50000hs.	50u.	1u.
R-C300-FW12-IP66	Rojo	625 NM	8WxM	180 lmxM	50000hs.	50u.	1u.
G-C300-FW12-IP66	Verde	520 NM	8WxM	960 lmxM	50000hs.	50u.	1u.
B-C300-FW12-IP66	Azul	460 NM	8WxM	120 lmxM	50000hs.	50u.	1u.
Y-C300-FW12-IP66	Amarillo	585 NM	8WxM	180 lmxM	50000hs.	50u.	1u.

TIRA 2835 / 120 LED X METRO / IP20 / 12V					VIDA ÚTIL	MASTER	VENTA MIN
WW-C600-FW12-IP20	Cálido	2700°K	16WxM	1.860 lmxM	50000hs.	50u.	1u.
CW-C600-FW12-IP20	Frío	6000°K	16WxM	1.860 lmxM	50000hs.	50u.	1u.

TIRA 2835 / 120 LED X METRO / IP20 / 24V					VIDA ÚTIL	MASTER	VENTA MIN
WW-C600-FW24-IP20	Cálido	2700°K	16WxM	1.860 lmxM	50000hs.	50u.	1u.
CW-C600-FW24-IP20	Frío	6000°K	16WxM	1.860 lmxM	50000hs.	50u.	1u.

TIRA 2216 / 300 LED X METRO / IP20 / 24V					VIDA ÚTIL	MASTER	VENTA MIN
WW-D1500-FW24-IP20	Cálido	2700°K	18WxM	1.600 lmxM	50000hs.	50u.	1u.



TIRA 5050 / 60 LED X METRO / IP20 / 12V					VIDA ÚTIL	MASTER	VENTA MIN
WW-B300-FW12-IP20	Cálido	2700°K	14.4WxM	1.425 lm x M	50000hs.	50u.	1u.
NW-B300-FW12-IP20	Neutro	4500°K	14.4WxM	1.450 lm x M	50000hs.	50u.	1u.
CW-B300-FW12-IP20	Frío	6500°K	14.4WxM	1.500 lm x M	50000hs.	50u.	1u.
R-B300-FW12-IP20	Rojo	625 NM	14.4WxM	360 lm x M	50000hs.	50u.	1u.
G-B300-FW12-IP20	Verde	520 NM	14.4WxM	1.140 lm x M	50000hs.	50u.	1u.
B-B300-FW12-IP20	Azul	460 NM	14.4WxM	300 lm x M	50000hs.	50u.	1u.
Y-B300-FW12-IP20	Amarillo	585 NM	14.4WxM	1.020 lm x M	50000hs.	50u.	1u.
AW-B300-FW12-IP20	Ambar	2200K	14.4WxM	1.020 lm x M	50000hs.	50u.	1u.
RGB-B300-FW12-IP20	RGB	-	-	Variable	50000hs.	50u.	1u.

TIRA 5050 / 60 LED X METRO / IP20 / 24V					VIDA ÚTIL	MASTER	VENTA MIN
WW-B300-FW24-IP20	Cálido	2700°K	14.4WxM	1.425 lm x M	50000hs.	50u.	1u.
CW-B300-FW24-IP20	Frío	6000°K	14.4WxM	1.500 lm x M	50000hs.	50u.	1u.

TIRA 5050 / 60 LED X METRO / IP45 / 12V					VIDA ÚTIL	MASTER	VENTA MIN
WW-B300-FW12-IP45	Cálido	2700°K	14.4WxM	1.425 lm x M	50000hs.	50u.	1u.
CW-B300-FW12-IP45	Frío	6000°K	14.4WxM	1.500 lm x M	50000hs.	50u.	1u.
R-B300-FW12-IP45	Rojo	625 NM	14.4WxM	360 lm x M	50000hs.	50u.	1u.
G-B300-FW12-IP45	Verde	520 NM	14.4WxM	1.140 lm x M	50000hs.	50u.	1u.
B-B300-FW12-IP45	Azul	460 NM	14.4WxM	300 lm x M	50000hs.	50u.	1u.
Y-B300-FW12-IP45	Amarillo	585 NM	14.4WxM	1.020 lm x M	50000hs.	50u.	1u.
RGB-B300-FW12-IP45	RGB	-	-	Variable	50000hs.	50u.	1u.

TIRA 5050 / 60 LED X METRO / IP66 / 12V					VIDA ÚTIL	MASTER	VENTA MIN
WW-B300-FW12-IP66	Cálido	2700°K	14.4WxM	1.425 lm x M	50000hs.	50u.	1u.
CW-B300-FW12-IP66	Frío	6000°K	14.4WxM	1.500 lm x M	50000hs.	50u.	1u.
R-B300-FW12-IP66	Rojo	625 NM	14.4WxM	360 lm x M	50000hs.	50u.	1u.
G-B300-FW12-IP66	Verde	520 NM	14.4WxM	1.140 lm x M	50000hs.	50u.	1u.
B-B300-FW12-IP66	Azul	460 NM	14.4WxM	300 lm x M	50000hs.	50u.	1u.
Y-B300-FW12-IP66	Amarillo	585 NM	14.4WxM	1.020 lm x M	50000hs.	50u.	1u.
RGB-B300-FW12-IP66	RGB	-	-	Variable	50000hs.	50u.	1u.

TIRA 5050 / 60 LED X METRO / IP66 / 24V					VIDA ÚTIL	MASTER	VENTA MIN
WW-B300-FW24-IP66	Cálido	3000°K	14.4WxM	1.500 lm x M	50000hs.	50u.	1u.
CW-B300-FW24-IP66	Frío	6000°K	14.4WxM	1.500 lm x M	50000hs.	50u.	1u.



CONECTOR 5050 SIMPLE		PINES	TAMAÑO	CABLE	MASTER
ELL-A2P-10-5050	Normal	2	10mm	0,5x150mm	100u.
ELL-E2P-RGB	RGB	4	10mm	0,5x150mm	100u.



CONECTOR 2835 / 3528 SIMPLE		PINES	TAMAÑO	CABLE	MASTER
ELL-A2P-8-3528	Normal	2	8mm	0,5x150mm	100u.



CONECTOR 5050 DOBLE		PINES	TAMAÑO	CABLE	MASTER
ELL-C2P-10-5050	Normal	2	10mm	0,5x150mm	100u.
ELL-D2P-RGB	RGB	4	10mm	0,5x150mm	100u.



CONECTOR 2835 / 3528 DOBLE		PINES	TAMAÑO	CABLE	MASTER
ELL-C2P-8-3528	Normal	2	8mm	0,5x150mm	100u.



CONECTOR 5050 SIN CABLE		PINES	TAMAÑO	CABLE	MASTER
ELL-B2P-10-5050	-	-	10mm	-	100u.



CONECTOR 2835/3528 SIN CABLE		PINES	TAMAÑO	CABLE	MASTER
ELL-B2P-8-3528	-	-	8mm	-	100u.



CONTROLADOR INFLAROJO / 5mts		MATERIAL	TAMAÑO	MASTER	VENTA MIN
CON-RGB-IR-72W		Plástico	61x35x22mm	200u	1u.



CONTROLADOR RADIOFRECUENCIA / 10mts		MATERIAL	TAMAÑO	MASTER	MASTER
CON-RGB-RF-144W		Metal	130x65x25mm	100u.	1u.



C. RADIOFRECUENCIA (C/ CONTROL) / 10mts		MATERIAL	TAMAÑO	MASTER	VENTA MIN
CON-RGB-RF-360W		Metal	121x75x25mm	100u.	1u.



C. RADIOFRECUENCIA RGB+W 288W		PWR MÁX (12V)	PWR MÁX (24V)	TAMAÑO	MASTER
CON-RGBW-RF-288W	12V-24V	288W	576W	85x45x23mm	100u. 1u.



CONTROLADORA SMART 144W		PWR MÁX (12V)	PWR MÁX (24V)	TAMAÑO	MASTER
CON-WIFI-IR-144W	12V-24V	144W	288W	135x22mm	100u. 1u.



DIMMER REMOTO		MATERIAL	TAMAÑO	MASTER	VENTA MIN
DIM-IR-96W		Plástico	87x87x53mm	84u.	1u.



DIMMER		MATERIAL	TAMAÑO	MASTER	VENTA MIN
DIM-M-96W		Plástico	89x59x35mm	160u.	1u.



AMPLIFICADOR / 10mts		MATERIAL	TAMAÑO	MASTER	VENTA MIN
AMP-RGB-12A		Metal	105x65x23mm	120u.	1u.

Acceso a la página web



CEE-IP65



CEE-IP65-X3



CEE-IP65-X4

CAJA ESTANCA IP65	CORRIENTE	PG9 (4-8mm)	M20 (4-12,7mm)	MASTER	VENTA MIN
CEE-IP65	450V máx.	16A. máx.	X2	-	100u.
CEE-IP65-X3	450V máx.	24A. máx.	X1	X2	100u.
CEE-IP65-X4	450V máx.	24A. máx.	X2	X2	100u.



FEE-IP65-X1-48



FEE-IP65-X1-912



FEE-IP65-X2-812

FICHAS EMPALME IP65	CORRIENTE	PG9 (4-8mm)	PRENSACABLES	PROTECCIÓN	MASTER	VENTA MÍN
FEE-IP65-X1-48	450V máx.	450V máx.	13.5A máx.	x2 PG9 (4-8mm)	IP65	500u.
FEE-IP65-X1-912	450V máx.	450V máx.	24A máx.	x2 M20 (9-12mm)	IP65	200u.
FEE-IP65-X2-812	450V máx.	450V máx.	32A máx.	x3 M25 (8-12mm)	IP65	100u.



ENCHUFE X2 USB	ENTRADA	USB SALIDA	TOMA SALIDA	MASTER	VENTA MÍN
EUSB-X2-AR	AC110-230V 50/60Hz	2x2,4A Total	10A 250V	40u.	10u.



PX5B-3



PX5N-1.5



PX5B-1.5



PX5B-2USB-1.5

PROLONGADORES X5 TOMAS	USB	POTENCIA	MASTER	VENTA MÍN	
PX5B-1.5	● Blanco	-	2200W Máx.	1,5mts 3x0,75mm	20u.
PX5B-3	○ Blanco	-	2200W Máx.	3mts 3x0,75mm	20u.
PX5N-1.5	● Negro	-	2200W Máx.	1,5mts 3x0,75mm	20u.
PX5B-2USB-1.5	○ Blanco	2	2200W Máx.	1,5mts 3x0,75mm	20u.



PX8B-1.5



PX8N-1.5



PX8B-2USB-3



PX8N-2USB-3

PROLONGADORES X8 TOMAS	USB	POTENCIA	MASTER	VENTA MÍN	
PX8B-1.5	● Blanco	-	2200W Máx.	1,5mts 3x0,75mm	10u.
PX8N-1.5	● Negro	-	2200W Máx.	1,5mts 3x0,75mm	10u.
PX8B-2USB-3	● Blanco	2	2200W Máx.	3mts 3x0,75mm	10u.
PX8N-2USB-3	● Negro	2	2200W Máx.	3mts 3x0,75mm	10u.

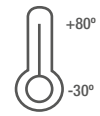

Temperatura
-30°C +80°C



Resiste los
rayos UV

PRECINTOS DE NYLON NEGRO	MEDIDA	DIÁMETRO	COLOR	RESISTENCIA	MASTER	UNID. X BOLSA	VENTA MÍN
PN25-100N	2.5x100mm	Ø 2-22mm	Negro	8KG	250 bolsas	100u.	1u.
PN36-150N	3.6x150mm	Ø 3-35mm	Negro	18KG	150 bolsas	100u.	1u.
PN48-200N	4.8x200mm	Ø 3-50mm	Negro	22KG	100 bolsas	100u.	1u.
PN48-250N	4.8x250mm	Ø 3-65mm	Negro	22KG	80 bolsas	100u.	1u.
PN48-300N	4.8x300mm	Ø 3-82mm	Negro	22KG	60 bolsas	100u.	1u.
PN48-350N	4.8x350mm	Ø 3-90mm	Negro	22KG	50 bolsas	100u.	1u.
PN48-400N	4.8x400mm	Ø 3-105mm	Negro	22KG	50 bolsas	100u.	1u.
PN48-450N	4.8x450mm	Ø 3-130mm	Negro	22KG	50 bolsas	100u.	1u.
PN48-500N	4.8x500mm	Ø 3-160mm	Negro	22KG	40 bolsas	100u.	1u.
PN76-300N	7.6x300mm	Ø 4-82mm	Negro	55KG	60 bolsas	50u.	1u.
PN76-350N	7.6x350mm	Ø 4-90mm	Negro	55KG	60 bolsas	50u.	1u.
PN76-400N	7.6x400mm	Ø 4-105mm	Negro	55KG	40 bolsas	50u.	1u.
PN76-450N	7.6x450mm	Ø 4-130mm	Negro	55KG	40 bolsas	50u.	1u.
PN76-550N	7.6x550mm	Ø 4-160mm	Negro	55KG	20 bolsas	50u.	1u.

PRECINTOS DE NYLON BLANCO	MEDIDA	DIÁMETRO	COLOR	RESISTENCIA	MASTER	UNID. X BOLSA	VENTA MÍN
PN25-100B	2.5x100mm	Ø 2-22mm	Blanco	8KG	250 bolsas	100u.	1u.
PN36-150B	3.6x150mm	Ø 3-35mm	Blanco	18KG	150 bolsas	100u.	1u.
PN48-200B	4.8x200mm	Ø 3-50mm	Blanco	22KG	100 bolsas	100u.	1u.
PN48-250B	4.8x250mm	Ø 3-65mm	Blanco	22KG	80 bolsas	100u.	1u.
PN48-300B	4.8x300mm	Ø 3-82mm	Blanco	22KG	60 bolsas	100u.	1u.
PN48-350B	4.8x350mm	Ø 3-90mm	Blanco	22KG	50 bolsas	100u.	1u.
PN48-400B	4.8x400mm	Ø 3-105mm	Blanco	22KG	50 bolsas	100u.	1u.
PN48-450B	4.8x450mm	Ø 3-130mm	Blanco	22KG	50 bolsas	100u.	1u.
PN48-500B	4.8x500mm	Ø 3-160mm	Blanco	22KG	40 bolsas	100u.	1u.
PN76-300B	7.6x300mm	Ø 4-82mm	Blanco	55KG	60 bolsas	50u.	1u.
PN76-350B	7.6x350mm	Ø 4-90mm	Blanco	55KG	60 bolsas	50u.	1u.
PN76-400B	7.6x400mm	Ø 4-105mm	Blanco	55KG	40 bolsas	50u.	1u.
PN76-450B	7.6x450mm	Ø 4-130mm	Blanco	55KG	40 bolsas	50u.	1u.
PN76-550B	7.6x550mm	Ø 4-160mm	Blanco	55KG	20 bolsas	50u.	1u.



CINTAS AISLADORA 5MTS		COLOR	MEDIDAS	MASTER	VENTA MÍN
CA-N-05	PVC	Negro	5 M.	500u.	10u.
CA-B-05	PVC	Blanco	5 M.	500u.	10u.
CA-A-05	PVC	Azul	5 M.	500u.	10u.
CA-R-05	PVC	Rojo	5 M.	500u.	10u.
CA-Y-05	PVC	Amarillo	5 M.	500u.	10u.
CA-V-05	PVC	Verde	5 M.	500u.	10u.
CA-T-05	PVC	Tierra	5 M.	500u.	10u.

CINTAS AISLADORA 10MTS		COLOR	MEDIDAS	MASTER	VENTA MÍN
CA-N-10	PVC	Negro	10 M.	500u.	10u.
CA-B-10	PVC	Blanco	10 M.	500u.	10u.
CA-A-10	PVC	Azul	10 M.	500u.	10u.
CA-R-10	PVC	Rojo	10 M.	500u.	10u.
CA-Y-10	PVC	Amarillo	10 M.	500u.	10u.
CA-V-10	PVC	Verde	10 M.	500u.	10u.
CA-T-10	PVC	Tierra	10 M.	500u.	10u.

CINTAS AISLADORA 20MTS		COLOR	MEDIDAS	MASTER	VENTA MÍN
CA-N-20	PVC	Negro	20 M.	250u.	10u.
CA-B-20	PVC	Blanco	20 M.	250u.	10u.
CA-A-20	PVC	Azul	20 M.	250u.	10u.
CA-R-20	PVC	Rojo	20 M.	250u.	10u.
CA-Y-20	PVC	Amarillo	20 M.	250u.	10u.
CA-V-20	PVC	Verde	20 M.	250u.	10u.
CA-T-20	PVC	Tierra	20 M.	250u.	10u.



PERFIL ESQUINERO



PERFIL EMBUTIR



PERFIL FLAT



PERFIL LISTÓN



PERFIL PVC ESQUINERO	PINES	TAMAÑO	CABLE	MASTER
PVC-ESQ-2M-BL	PVC	2 mts.	Blanco	20u.
PVC-ESQ-2M-GR	PVC	2 mts.	Gris	20u.
PVC-ESQ-2M-NG	PVC	2 mts.	Negro	20u.

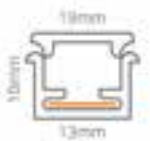

PERFIL PVC EMBUTIR	TAMAÑO	CABLE	MASTER	
PVC-E-2M-BL	PVC	2 mts.	Blanco	20u.
PVC-E-2M-GR	PVC	2 mts.	Gris	20u.
PVC-E-2M-NG	PVC	2 mts.	Negro	20u.



PERFIL PVC FLAT	TAMAÑO	CABLE	MASTER	
PVC-F-2M-BL	PVC	2 mts.	Blanco	20u.
PVC-F-2M-GR	PVC	2 mts.	Gris	20u.
PVC-F-2M-NG	PVC	2 mts.	Negro	20u.



PERFIL PVC LISTÓN	PINES	TAMAÑO	CABLE	MASTER
PVC-L-2M-BL	PVC	2 mts.	Blanco	20u.
PVC-L-2M-GR	PVC	2 mts.	Gris	20u.
PVC-L-2M-NG	PVC	2 mts.	Negro	20u.

Características Generales

<p>Vista Frontal Toma</p>	3P (1+N+T)			
	220V			
	Tensión	AC220-250V~	Garantía	1 año
	Frecuencia	50-60Hz	Temperatura	-25°C+40°C
	Polos	1+N+T	Norma	IEC 60309
Posición Tierra	6H	Terminales	Aleación Cobre HPB58-3	

Móviles

	TOMA IP44	A	EAN13	CABLE	PESO	INTER/MASTER
	IFI-TM3-16A220V-IP44	16A	7428325590700	1.5-2.5	133.6	10/120
	IFI-TM3-32A220V-IP44	32A	7428325590731	4-6	225.2	10/90
	IFI-TM3-63A220V-IP44	63A	7428325594616	10-16	596.8	5/30

	TOMA IP67	A	EAN13	CABLE	PESO	INTER/MASTER
	IFI-TM3-16A220V-IP67	16A	7428325590793	1.5-2.5	143.4	10/90
	IFI-TM3-32A220V-IP67	32A	7428325590823	4-6	326.5	10/90
	IFI-TM3-63A220V-IP67	63A	7428325590854	10-16	625.8	5/30
	IFI-TM3-125A220V-IP67	125A	7428325590885	25-35	1082.2	5/20

	FICHA IP44	A	EAN13	CABLE	PESO	INTER/MASTER
	IFI-FM3-16A220V-IP44	16A	7428325590496	1.5-2.5	109.3	10/120
	IFI-FM3-32A220V-IP44	32A	7428325590526	4-6	173.9	10/90
	IFI-FM3-63A220V-IP44	63A	7428325590557	10-16	471.4	5/30

	FICHA IP67	A	EAN13	CABLE	PESO	INTER/MASTER
	IFI-FM3-16A220V-IP67	16A	7428325590588	1.5-2.5	123.3	10/90
	IFI-FM3-32A220V-IP67	32A	7428325590618	4-6	209.8	10/90
	IFI-FM3-63A220V-IP67	63A	7428325590649	10-16	552.6	5/30
	IFI-FM3-125A220V-IP67	125A	7428325590670	25-35	960	5/20

Embutir

	TOMA IP44	A	EAN13	CABLE	PESO	INTER/MASTER
	IFI-TE3-16A220V-IP44	16A	7428325590915	1.5-2.5	136.2	10/120
	IFI-TE3-32A220V-IP44	32A	7428325590946	4-6	156.6	10/90
	IFI-TE3-63A220V-IP44	63A	7428325590977	10-16	463.8	5/30

	TOMA IP67	A	EAN13	CABLE	PESO	INTER/MASTER
	IFI-TE3-16A220V-IP67	16A	7428325591004	1.5-2.5	122.8	10/120
	IFI-TE3-32A220V-IP67	32A	7428325591035	4-6	194.4	10/80
	IFI-TE3-63A220V-IP67	63A	7428325591066	10-16	514	5/20
	IFI-TE3-125A220V-IP67	125A	7428325591097	25-35	912.8	5/20

	FICHA IP44	A	EAN13	CABLE	PESO	INTER/MASTER
	IFI-FE3-16A220V-IP44	16A	7428325591332	1.5-2.5	74.2	10/120
	IFI-FE3-32A220V-IP44	32A	7428325591363	4-6	106	10/120
	IFI-FE3-63A220V-IP44	63A	7428325591394	10-16	364.4	5/40

	FICHA IP67	A	EAN13	CABLE	PESO	INTER/MASTER
	IFI-FE3-16A220V-IP67	16A	7428325591424	1.5-2.5	109.3	10/90
	IFI-FE3-32A220V-IP67	32A	7428325591455	4-6	173.9	10/60
	IFI-FE3-63A220V-IP67	63A	7428325591486	10-16	471.4	5/40
	IFI-FE3-125A220V-IP67	125A	7428325591516	25-35	798.4	5/20

Superficie

	TOMA IP44	A	EAN13	CABLE	PESO	INTER/MASTER
	IFI-TS3-16A220V-IP44	16A	7428325591127	1.5-2.5	183.9	10/60
	IFI-TS3-32A220V-IP44	32A	7428325591158	4-6	242.8	10/60
	IFI-TS3-63A220V-IP44	63A	7428325591189	10-16	815	5/20

	TOMA IP67	A	EAN13	CABLE	PESO	INTER/MASTER
	IFI-TS3-16A220V-IP67	16A	7428325591219	1.5-2.5	238.8	10/60
	IFI-TS3-32A220V-IP67	32A	7428325591240	4-6	312.4	10/40
	IFI-TS3-63A220V-IP67	63A	7428325591271	10-16	820	5/20
IFI-TS3-125A220V-IP67	125A	7428325591301	25-35	1461.8	2/8	

	FICHA IP44	A	EAN13	CABLE	PESO	INTER/MASTER
	IFI-FS3-16A220V-IP44	16A	7428325591547	1.5-2.5	158,6	10/90
	IFI-FS3-32A220V-IP44	32A	7428325591578	4-6	189.4	10/90
IFI-FS3-63A220V-IP44	63A	7428325591608	10-16	735	5/20	

	FICHA IP67	A	EAN13	CABLE	PESO	INTER/MASTER
	IFI-FS3-16A220V-IP67	16A	7428325591639	1.5-2.5	245	10/60
	IFI-FS3-32A220V-IP67	32A	7428325591660	4-6	380.6	10/40
	IFI-FS3-63A220V-IP67	63A	7428325591691	10-16	851.2	5/20
IFI-FS3-125A220V-IP67	125A	7428325591721	25-35	1385	2/8	

Prolongadores múltiples

	DOBLE IP44	A	EAN13	CABLE	PESO	INTER/MASTER
	IFI-TPD3-16A220V-IP44	16A	7428325591752	1.5-2.5	351.6	6/36
IFI-TPD3-32A220V-IP44	32A	7428325591783	4-6	613	4/24	

	TRIPLE IP44	A	EAN13	CABLE	PESO	INTER/MASTER
	IFI-TPT3-16A220V-IP44	16A	7428325591875	1.5-2.5	468	6/36
IFI-TPT3-32A220V-IP44	32A	7428325591905	4-6	843	4/16	

	DOBLE IP67	A	EAN13	CABLE	PESO	INTER/MASTER
	IFI-TPD3-16A220V-IP67	16A	7428325591813	1.5-2.5	418.4	6/36
IFI-TPD3-32A220V-IP67	32A	7428325591844	4-6	715	2/8	

	TRIPLE IP67	A	EAN13	CABLE	PESO	INTER/MASTER
	IFI-TPT3-16A220V-IP67	16A	7428325591936	1.5-2.5	559.2	6/36
IFI-TPT3-32A220V-IP67	32A	7428325591967	4-6	986	2/8	

Características Generales

<p>Vista Frontal Toma</p>	4P (3+T)				
	380V				
	Tensión	AC380-415V~	Garantía	1 año	
	Frecuencia	50-60Hz	Temperatura	-25°C+40°C	
	Polos	3+T	Norma	IEC 60309	
Posición Tierra	6H	Terminales	Aleación Cobre HPB58-3		

Móviles

	TOMA IP44	A	EAN13	CABLE	PESO	INTER/MASTER
	IFI-TM4-16A380V-IP44	16A	7428325590717	1.5-2.5	156	10/90
	IFI-TM4-32A380V-IP44	32A	7428325590748	4-6	238.2	10/90
	IFI-TM4-63A380V-IP44	63A	7428325590779	10-16	597	5/30

	TOMA IP67	A	EAN13	CABLE	PESO	INTER/MASTER
	IFI-TM4-16A380V-IP67	16A	7428325590809	1.5-2.5	189	10/90
	IFI-TM4-32A380V-IP67	32A	7428325590830	4-6	275.1	10/90
	IFI-TM4-63A380V-IP67	63A	7428325590861	10-16	658.2	5/30
	IFI-TM4-125A380V-IP67	125A	7428325590892	25-35	1169.2	5/20

	FICHA IP44	A	EAN13	CABLE	PESO	INTER/MASTER
	IFI-FM4-16A380V-IP44	16A	7428325590502	1.5-2.5	127.9	10/120
	IFI-FM4-32A380V-IP44	32A	7428325590533	4-6	189.6	10/90
	IFI-FM4-63A380V-IP44	63A	7428325590564	10-16	520.8	5/30

	FICHA IP67	A	EAN13	CABLE	PESO	INTER/MASTER
	IFI-FM4-16A380V-IP67	16A	7428325590595	1.5-2.5	149.4	10/120
	IFI-FM4-32A380V-IP67	32A	7428325590625	4-6	223	10/60
	IFI-FM4-63A380V-IP67	63A	7428325590656	10-16	594.1	5/30
	IFI-FM4-125A380V-IP67	125A	7428325590687	25-35	1067.2	5/20

Embutir

	TOMA IP44	A	EAN13	CABLE	PESO	INTER/MASTER
	IFI-TE4-16A380V-IP44	16A	7428325590922	1.5-2.5	123.2	10/120
	IFI-TE4-32A380V-IP44	32A	7428325590953	4-6	177	10/120
	IFI-TE4-63A380V-IP44	63A	7428325590984	10-16	493.8	5/20

	TOMA IP67	A	EAN13	CABLE	PESO	INTER/MASTER
	IFI-TE4-16A380V-IP67	16A	7428325591011	1.5-2.5	152.6	10/120
	IFI-TE4-32A380V-IP67	32A	7428325591042	4-6	212.6	10/80
	IFI-TE4-63A380V-IP67	63A	7428325591073	10-16	549	5/20
	IFI-TE4-125A380V-IP67	125A	7428325591103	25-35	1005.4	5/20

	FICHA IP44	A	EAN13	CABLE	PESO	INTER/MASTER
	IFI-FE4-16A380V-IP44	16A	7428325591349	1.5-2.5	90.6	10/120
	IFI-FE4-32A380V-IP44	32A	7428325591370	4-6	123.2	10/120
	IFI-FE4-63A380V-IP44	63A	7428325591400	10-16	410	5/40

	FICHA IP67	A	EAN13	CABLE	PESO	INTER/MASTER
	IFI-FE4-16A380V-IP67	16A	7428325591431	1.5-2.5	173.6	10/90
	IFI-FE4-32A380V-IP67	32A	7428325591462	4-6	241.6	10/60
	IFI-FE4-63A380V-IP67	63A	7428325591493	10-16	482.8	5/40
	IFI-FE4-125A380V-IP67	125A	7428325591523	25-35	908.4	5/20

Superficie

	TOMA IP44	A	EAN13	CABLE	PESO	INTER/MASTER
	IFI-TS4-16A380V-IP44	16A	7428325591134	1.5-2.5	207.3	10/60
	IFI-TS4-32A380V-IP44	32A	7428325591165	4-6	263	10/60
	IFI-TS4-63A380V-IP44	63A	7428325591196	10-16	868.9	5/20

	TOMA IP67	A	EAN13	CABLE	PESO	INTER/MASTER
	IFI-TS4-16A380V-IP67	16A	7428325591226	1.5-2.5	270.6	10/40
	IFI-TS4-32A380V-IP67	32A	7428325591257	4-6	326.5	10/40
	IFI-TS4-63A380V-IP67	63A	7428325591288	10-16	896	5/20
	IFI-TS4-125A380V-IP67	125A	7428325591318	25-35	1586.2	2/8

	FICHA IP44	A	EAN13	CABLE	PESO	INTER/MASTER
	IFI-FS4-16A380V-IP44	16A	7428325591554	1.5-2.5	174.2	10/90
	IFI-FS4-32A380V-IP44	32A	7428325591585	4-6	208.1	10/90
	IFI-FS4-63A380V-IP44	63A	7428325591615	10-16	782	5/20

	FICHA IP67	A	EAN13	CABLE	PESO	INTER/MASTER
	IFI-FS4-16A380V-IP67	16A	7428325591646	1.5-2.5	270.4	10/60
	IFI-FS4-32A380V-IP67	32A	7428325591677	4-6	396.6	10/40
	IFI-FS4-63A380V-IP67	63A	7428325591707	10-16	917	5/20
	IFI-FS4-125A380V-IP67	125A	7428325591738	25-35	1480.2	2/8

Prolongadores múltiples

	DOBLE IP44	A	EAN13	CABLE	PESO	INTER/MASTER
	IFI-TPD4-16A380V-IP44	16A	7428325591769	1.5-2.5	430	6/36
	IFI-TPD4-32A380V-IP44	32A	7428325591790	4-6	670	4/24

	TRIPLE IP44	A	EAN13	CABLE	PESO	INTER/MASTER
	IFI-TPT4-16A380V-IP44	16A	7428325591882	1.5-2.5	594.2	6/36
	IFI-TPT4-32A380V-IP44	32A	7428325591912	4-6	932	4/16

	DOBLE IP67	A	EAN13	CABLE	PESO	INTER/MASTER
	IFI-TPD4-16A380V-IP67	16A	7428325591820	1.5-2.5	515.8	6/36
	IFI-TPD4-32A380V-IP67	32A	7428325591851	4-6	782	2/8

	TRIPLE IP67	A	EAN13	CABLE	PESO	INTER/MASTER
	IFI-TPT4-16A380V-IP67	16A	7428325591943	1.5-2.5	712.2	6/36
	IFI-TPT4-32A380V-IP67	32A	7428325591974	4-6	1063.4	2/8

Características Generales

<p>Vista Frontal Toma</p>	5P (3+N+T)				
	380V				
	Tensión	AC380-415V~	Garantía	1 año	
	Frecuencia	50-60Hz	Temperatura	-25°C+40°C	
	Polos	3+N+T	Norma	IEC 60309	
Posición Tierra	6H	Terminales	Aleación Cobre HPB58-3		

Móviles

	TOMA IP44	A	EAN13	CABLE	PESO	INTER/MASTER
	IFI-TM5-16A380V-IP44	16A	7428325590724	1.5-2.5	176.8	10/90
	IFI-TM5-32A380V-IP44	32A	7428325590755	4-6	274.3	10/60
	IFI-TM5-63A380V-IP44	63A	7428325590786	10-16	643.8	5/30

	TOMA IP67	A	EAN13	CABLE	PESO	INTER/MASTER
	IFI-TM5-16A380V-IP67	16A	7428325590816	1.5-2.5	238.8	10/90
	IFI-TM5-32A380V-IP67	32A	7428325590847	4-6	312.4	10/40
	IFI-TM5-63A380V-IP67	63A	7428325590878	10-16	820	5/30
	IFI-TM5-125A380V-IP67	125A	7428325590908	25-35	1461.8	5/20

	FICHA IP44	A	EAN13	CABLE	PESO	INTER/MASTER
	IFI-FM5-16A380V-IP44	16A	7428325590519	1.5-2.5	148.8	10/90
	IFI-FM5-32A380V-IP44	32A	7428325590540	4-6	221.2	10/90
	IFI-FM5-63A380V-IP44	63A	7428325590571	10-16	566.2	5/30

	FICHA IP67	A	EAN13	CABLE	PESO	INTER/MASTER
	IFI-FM5-16A380V-IP67	16A	7428325590601	1.5-2.5	172.4	10/60
	IFI-FM5-32A380V-IP67	32A	7428325590632	4-6	256.7	10/40
	IFI-FM5-63A380V-IP67	63A	7428325590663	10-16	638.7	5/20
	IFI-FM5-125A380V-IP67	125A	7428325590694	25-35	1186.8	2/8

Embutir

	TOMA IP44	A	EAN13	CABLE	PESO	INTER/MASTER
	IFI-TE5-16A380V-IP44	16A	7428325590939	1.5-2.5	136.2	10/120
	IFI-TE5-32A380V-IP44	32A	7428325590960	4-6	208.2	10/120
	IFI-TE5-63A380V-IP44	63A	7428325590991	10-16	256.2	5/20

	TOMA IP67	A	EAN13	CABLE	PESO	INTER/MASTER
	IFI-TE5-16A380V-IP67	16A	7428325591028	1.5-2.5	171.4	10/80
	IFI-TE5-32A380V-IP67	32A	7428325591059	4-6	250	10/60
	IFI-TE5-63A380V-IP67	63A	7428325591080	10-16	589	5/20
	IFI-TE5-125A380V-IP67	125A	7428325591110	25-35	1111.2	5/20

	FICHA IP44	A	EAN13	CABLE	PESO	INTER/MASTER
	IFI-FE5-16A380V-IP44	16A	7428325591356	1.5-2.5	104.6	10/120
	IFI-FE5-32A380V-IP44	32A	7428325591387	4-6	145.6	10/120
	IFI-FE5-63A380V-IP44	63A	7428325591417	10-16	458.8	5/40

	FICHA IP67	A	EAN13	CABLE	PESO	INTER/MASTER
	IFI-FE5-16A380V-IP67	16A	7428325591448	1.5-2.5	195.2	10/90
	IFI-FE5-32A380V-IP67	32A	7428325591479	4-6	285.4	10/60
	IFI-FE5-63A380V-IP67	63A	7428325591509	10-16	529.4	5/40
	IFI-FE5-125A380V-IP67	125A	7428325591530	25-35	1012.8	5/20

Superficie

	TOMA IP44	A	EAN13	CABLE	PESO	INTER/MASTER
	IFI-TS5-16A380V-IP44	16A	7428325591141	1.5-2.5	219.4	10/60
	IFI-TS5-32A380V-IP44	32A	7428325591172	4-6	293.7	10/60
	IFI-TS5-63A380V-IP44	63A	7428325591202	10-16	888	5/20

	TOMA IP67	A	EAN13	CABLE	PESO	INTER/MASTER
	IFI-TS5-16A380V-IP67	16A	7428325591233	1.5-2.5	288.8	10/40
	IFI-TS5-32A380V-IP67	32A	7428325591264	4-6	362.6	10/60
	IFI-TS5-63A380V-IP67	63A	7428325591295	10-16	933.6	5/20
	IFI-TS5-125A380V-IP67	125A	7428325591325	25-35	1706.4	2/8

	FICHA IP44	A	EAN13	CABLE	PESO	INTER/MASTER
	IFI-FS5-16A380V-IP44	16A	7428325591561	1.5-2.5	218.2	10/90
	IFI-FS5-32A380V-IP44	32A	7428325591592	4-6	231.4	10/90
	IFI-FS5-63A380V-IP44	63A	7428325591622	10-16	821.8	5/20

	FICHA IP67	A	EAN13	CABLE	PESO	INTER/MASTER
	IFI-FS5-16A380V-IP67	16A	7428325591653	1.5-2.5	302.8	10/60
	IFI-FS5-32A380V-IP67	32A	7428325591684	4-6	432.2	10/40
	IFI-FS5-63A380V-IP67	63A	7428325591714	10-16	968.6	5/20
	IFI-FS5-125A380V-IP67	125A	7428325591745	25-35	1466.6	2/8

Prolongadores múltiples

	DOBLE IP44	A	EAN13	CABLE	PESO	INTER/MASTER
	IFI-TPD5-16A380V-IP44	16A	7428325591776	1.5-2.5	502	6/36
	IFI-TPD5-32A380V-IP44	32A	7428325591806	4-6	836	4/16

	TRIPLE IP44	A	EAN13	CABLE	PESO	INTER/MASTER
	IFI-TPT5-16A380V-IP44	16A	7428325591899	1.5-2.5	682	6/36
	IFI-TPT5-32A380V-IP44	32A	7428325591929	4-6	1129.2	4/16

	DOBLE IP67	A	EAN13	CABLE	PESO	INTER/MASTER
	IFI-TPD5-16A380V-IP67	16A	7428325591837	1.5-2.5	597.4	4/24
	IFI-TPD5-32A380V-IP67	32A	7428325591868	4-6	953.6	2/8

	TRIPLE IP67	A	EAN13	CABLE	PESO	INTER/MASTER
	IFI-TPT5-16A380V-IP67	16A	7428325591950	1.5-2.5	825.8	6/36
	IFI-TPT5-32A380V-IP67	32A	7428325591981	4-6	1303.8	2/8



DRIVER INTERIOR	MATERIAL	(W-A)	ENTRADA	SALIDA	MASTER	VENTA MIN
PD-12W-12V	Plástico	12W - 1A	100-240V	12V	360u.	1u.
PD-25W-12V	Plástico	25W - 2.1A	100-240V	12V	256u.	1u.



FUENTE INTERIOR 12V	MATERIAL	(W-A)	ENTRADA	SALIDA	MASTER	VENTA MIN
S-25W-12V	Metal	25W-2.1A	100-240V	12V	100u	1u.
S-35W-12V	Metal	35W-3A	100-240V	12V	100u	1u.
S-50W-12V	Metal	50W-4A	100-240V	12V	80u	1u.
S-60W-12V	Metal	60W-5A	100-240V	12V	80u	1u.
S-75W-12V	Metal	75W-6A	100-240V	12V	40u	1u.
S-100W-12V	Metal	100W-8A	100-240V	12V	30u	1u.
S-120W-12V	Metal	120W-10A	100-240V	12V	30u	1u.
S-150W-12V	Metal	150W-12A	100-240V	12V	24u	1u.
S-201W-12V	Metal	201W-17A	100-240V	12V	20u	1u.
S-350W-12V	Metal	350W-29A	100-240V	12V	20u	1u.



FUENTE INTERIOR 24V	MATERIAL	(W-A)	ENTRADA	SALIDA	MASTER	VENTA MIN
S-35W-24V	Metal	35W-1,5A	100-240V	24V	100u	1u.
S-75W-24V	Metal	75W-3A	100-240V	24V	40u	1u.
S-120W-24V	Metal	120W-5A	100-240V	24V	30u	1u.
S-201W-24V	Metal	201W-8,5A	100-240V	24V	20u	1u.
S-350W-24V	Metal	350W-14,5A	100-240V	24V	20u	1u.



FUENTE EXTERIOR 12V	MATERIAL	(W-A)	ENTRADA	SALIDA	MASTER	VENTA MIN
BG-30W-12V	Metal	30W-2.5A	100-240V	12V	100u	1u
BG-60W-12V	Metal	60W-5A	100-240V	12V	32u	1u
BG-100W-12V	Metal	100W-8A	100-240V	12V	21u	1u
BG-150W-12V	Metal	150W-12.5A	100-240V	12V	16u	1u



FUENTE EXTERIOR 24V	MATERIAL	(W-A)	ENTRADA	SALIDA	MASTER	VENTA MIN
BG-60W-24V	Metal	60W-2.5A	100-240V	24V	32u	1u
BG-150W-24V	Metal	150W-6.2A	100-240V	24V	16u	1u



FUENTE INTERIOR 24V (RIEL DIN)		(W-A)	ENTRADA	SALIDA	MASTER	VENTA MIN.
DR-60W-12V	Plástico	60W - 5A	100-240V	12V	50u.	1u.
DR-120W-12V	Metal	120W - 10A	100-240V	12V	20u.	1u.
DR-240W-12V	Metal	240W - 20A	100-240V	12V	12u.	1u.



FUENTE INTERIOR 24V (RIEL DIN)		(W-A)	ENTRADA	SALIDA		VENTA MIN
DR-60W-24V	Plástico	60W - 2,5A	100-240V	24V	50u.	1u.
DR-120W-24V	Metal	120W - 5A	100-240V	24V	20u.	1u.
DR-240W-24V	Metal	240W - 10A	100-240V	24V	12u.	1u.